

2019

GeoFit
e v o l u t i o n



plus
murogeopietra



murogeopietra

Manual TECHNICAL





CREATE YOUR OWN WALL seek the ambience of an era

Geopietra has always created unique customised walls and is now making **the research and development laboratory** available to customers to provide an even more effective and thorough service. **Creating a customised wall with the new service in department is quick, easy and reliable.** By sending photographs of the walls to be created, we can produce ad hoc designs with combinations of the most appropriate stone, matching grout colour and finish, and send snaps of **the murogeopietra proposed solution.**

A sample panel can be made up to check the solution on site on customer request.



INDEX

MUROGEOPIETRA	04		
ABITASISTEMA	07		
GEOPIETRA®	12		
GEOFIT SMALL / BIG / SASSO	14		
GEOCOVER THE WALL CAPS / MODEL SPACCO	18		
1 GENERAL INFORMATION	20		
1.1 LIMITS OF USE	20		
1.2 INITIAL APPEARANCE OF THE MATERIAL	21		
2 MATERIAL CALCULATIONS	22		
2.1 MATERIAL CALCULATION FOR LISTELLO RIGO	24		
3 WATERPROOFING	25		
3.1 RETAINING WALLS	26		
3.2 DOWNPIPE FLASHING	28		
3.3 TERRACES: PAVING and PARAPETS	30		
3.4 BUILT-IN GUTTERS	31		
3.5 END-OF-WALL PROTECTION with FLASHING	32		
3.6 DOOR and WINDOW BORDERS	32		
3.7 THERMAL PROTECTION with COPING	33		
3.8 THERMAL PROTECTION with GEOCOVER COPING	34		
3.9 WALL TOPS in MANUFACTURED STONE	38		
4 ASSESSMENT OF THE BASE	39		
4.1 MISTAKES TO AVOID	39		
5 MECHANICAL ANCHORING with GEORETE and GEOTASSELLO	40		
6 PREPARATION OF THE BASE	42		
6.1 BRICK	42		
6.2 BLOCKS OF FOAM CONCRETE	42		
6.3 REINFORCED CONCRETE	42		
6.4 IRON	42		
6.5 HEAT-INSULATED PLASTER	43		
6.6 READY-MIXED PLASTERS	43		
6.7 VARIOUS PAINTS OR FILM FINISHES	43		
6.8 BASES WITH RISING DAMP	43		
6.9 BASE TREATMENTS	44		
6.10 TAR OVERLAP	44		
6.11 GYPSUM PLASTER FOR INDOOR	44		
6.12 PLASTERBOARD	44		
6.13 MINERAL WOOD FIBRE PANELS	44		
6.14 WOOD FIBRE BLOCKS	45		
6.15 LOOSE BASES	45		
6.16 WATER AND STEAM	45		
6.17 FIREPLACES AND STOVE AREAS	45		
6.18 INSTALLATION ON WATERPROOFED WALLS	45		
6.19 EXTERNAL VENTILATED WALLS	46		
6.20 WOOD AND MIXED STRUCTURES	46		
6.20.1 WOOD PANELS TYPE OSB	47		
6.20.2 WOODEN HOUSES	47		
COVERING IRON AND WOODEN PILLARS	48		
6.21 INSTALLATION ON EXTERNAL THERMAL INSULATION	49		
GUARANTEED PROCEDURE	49		
GENERAL STRATIGRAPHY	49		
MECHANICAL FIXING - DRILLING SCHEME	50		
6.22 INSTALLATION ON EXISTING PLATED EXTERNAL THERMAL INSULATION	53		
7 GEOCOLL® ADHESIVE	54		
8 WET-ON-WET INSTALLATION	55		
9 INSTALLATION TECHNIQUE	56		
9.1 LONG HORIZONTAL COURSES	58		
9.2 PANEL MODELS	58		
9.3 EXPANSION JOINTS	59		
9.4 INSTALLATION TIMES	59		
9.5 MUROGEOPIETRA PLUS DRY-STACKING LAYING	60		
10 BREAKAGE AND DETACHMENT	62		
11 INSTALLATION RULES	66		
11.1 WINDOWS AND DOORS Tips for installing on EXTERNAL THERMAL INSULATION	70		
11.2 INSERTING WOODEN ARCHITRAVES	75		
11.3 CANTONALE	75		
12 GEOBI GROUTING MORTAR	76		
13 GROUTING TECHNIQUE	78		
14 SURFACE FINISH	80		
15 TERRAKOTTA: BRICK SLIPS	84		
15.1 INSTALLING TERRAKOTTA BRICK	84		
16 CLEANING AND MAINTENANCE	86		
17 GUARANTEES	87		
18 LIGHTING PROJECT: OTTAGONO, STRIKER & CAPRI	88		
18.1 INSTALLATION INOX FRAME and CASE	89		

murogeopietra

GEOCOLL + GEOPIETRA + GEOBI

Installation and evolved materials in a single integrated system

murogeopietra is marketed as a single integrated system. It uses the Geocoll levelling glue system, state-of-the-art laying of the GEOPIETRA cladding on a previously prepared base and the application of the GEOBI two-component mortar.



murogeopietra is currently the only manufactured stone and brick veneer that meets the needs of external insulation systems and improves their performance.



murogeopietra

The first earthquake proof stone veneer wall in Europe, even on exterior thermal insulation.

As a major player in the construction industry, Geopietra is committed to obtain the certification of its products and installation processes so as to provide the best guarantee of use on site.

FRANCE July 2016 | Murogeopietra system has brilliantly passed all the tests on materials and installation procedures requested by the French public authority **CSTB / Centre Scientifique et Technique du Bâtiment**. It also obtained the Technical Evaluation (Avis Technique) and the Document Technique d'Application (DTA) by the committee (CCFAT) **for its suitability for use in innovative construction methods.**

murogeopietra



MUROGEOPIETRA TECHNICAL PERFORMANCE

MAIN BENEFITS OF MUROGEOPIETRA LAID ON EXTERNAL THERMAL INSULATION AND VENTILATED WALLS.

Thermal resistance

On structures exposed to fire hazards (wooden structures, EPS thermal insulation), the presence of **murogeopietra** makes the insulation cladding resistant to fire for longer, thus facilitating the evacuation of the building during a fire.

Improved sound performance

The asymmetric surface of **murogeopietra** (especially in models with a more rugged texture) creates a barrier against sound waves. The veneer mass overlaps the structural mass and attenuates sound propagation.

Increased thermal lag

Thanks to the excellent mass-to-thermal conductivity ratio, **murogeopietra** enhances insulation and extends the thermal lag of the building structure, thus increasing cooling performance in the summer months.

murogeopietra is known and appreciated for its unequalled aesthetic qualities, and can add numerous benefits to the efficiency of buildings.

murogeopietra expresses its best technical properties in the cladding of external thermal insulation systems and enhances its overall performance.

Thermal protection

The high thermal inertia of **murogeopietra** acts as a shield against surface thermal shocks, which are the main cause of the collapse of external insulation systems, since temperature variations (even sudden in certain circumstances) do not directly hit the insulation layer but they are dampened by the protective outer cladding.

Wind load resistance

murogeopietra, combined with the **Georete** mesh base and the safety screw anchoring system, helps reduce problems due to high wind load.

Enhanced surface performance

murogeopietra protects the surface of the insulation layer against any dents.

abitasistema



The only **guaranteed method** for the installation of **murogeopietra** on external wall thermal insulation cladding.



Geopietra ensures the Murogeopietra laying method on an ETAG 004-certified exterior wall thermal insulation system using EPS, rockwool and cork panels.



Unique technical performance

1. Thermal resistance
2. Increased thermal lag
3. Fire resistance
4. Wind load resistance
5. Enhanced surface performance
6. Improved sound performance

CSTB LABORATORY TESTS

CSTB - Eurocode 8 Quake proof Test UNI EN 1998-1 FRANCE July, 4th 2016

Building planning for quake resistance.

Regulation establishes the essential requirements applicable to buildings and civil engineering in an earthquake zone and provides the rules to represent seismic actions and their combining with other actions, in order to safeguard lives in case of earthquake, to limit damages and permit to civil protection's most important structures to remain safe.



1. Wall installation on the machine simulator.
2. Execution of the 8 phases of the seismic stress test.
3. Wall checked by the technicians on site after the test:
No collapses, detachments or cracks have been observed.



muregeopietra on concrete blocks

muregeopietra on 200 mm thermal insulation EPS

CSTB - Test SBI (Single Burning Item) / Determining material's fire and smoke classes. EN 13823 FRANCE July, 4th 2016

Herewith we report some data regarding the fire test made on wall covering muregeopietra installed on 160 mm external thermal EPS insulation; **this test confirms muregeopietra as a not flammable material and attests a complete lack of toxic smoke development.**

This means that **muregeopietra protects the underlying insulation against heat**, so that sublimation is avoided during the time necessary for evacuation.



MAIN EVENTS RECORDED DURING THE TEST			
Surface flashings?	NO	Distortion / collapse of specimen?	NO
Falling specimen parts?	NO	Mutual fixing of backing board failed?	NO
Smoke not entering hood?	NO		

POTENTIAL CLASSIFICATION		
CLASS	SMOKE PRODUCTION	FLAMING DROPLETS PARTICLES
A2/B	s1	d0

This important Fire Test confirms and integrates the results obtained in Austria in 2010 at the IBS - Institut für Brandschutztechnik und Sicherheitsforschung GmbH

MANY LABORATORY TESTS

2010 - CLIMATIC CHAMBER

Firmly convinced of the possibility of creating a stone veneer on an insulation coating, we were mainly concerned about the occurrence of any collapse over time and, no less important, a deterioration of the thermal properties of the insulation. **Laboratory test results have led us to modify the ingredients of Murogeopietra several times until we obtained a perfect balance.**



Austria 2010 - FIRE TEST IBS Institut für Brandschutztechnik und Sicherheitsforschung GmbH

Great importance was given to safety at the design stage. In Europe there are specific regulations governing escape routes in case of fire. In the case in point, our Murogeopietra cladding system coupled with the EPS insulation coating, which is notoriously sensitive to fire, was not supposed to collapse and obstruct the escape routes during evacuation of the building, which was **established in 30 minutes under the action of a flame hitting the escape route directly at 900°C**. The test was successful and the insulation (on the whole height of 6 metres) did not collapse at all thanks to the stone veneer's high thermal inertia, which protected it for the entire time required.



Italy 2014 - CLIMATIC CHAMBER ACCELERATED AGEING on exterior thermal insulation.

We were greatly concerned about the possible presence of water in the structure due to external weathering or the passage of vapour and its disposal. A test performed at **Milan Polytechnic** confirmed the validity of the system and the corrections made to the ingredients used. At the same time, we tested the same insulation cladding coated with **cut natural stone**, and we found that it **was impossible to use**, just as we had supposed. The non-modifiable technical values, such as permeability to vapour and weight, significantly affect the efficiency of insulation.





The guaranteed murogeopietra installation solution on EPS preserves the solidity of the façade.

The new LEPIR II test confirms that the **murogeopietra** solution on **EPS** fully complies with fire safety standards for buildings.

Geopietra has always been committed to developing innovative materials and installation methods, obtaining endorsements for its products, providing the best guarantees for use on premises, and ensuring the safety and efficiency of the property solutions created.

In 2018 Geopietra deemed it necessary to also validate this process on the façades of buildings subject to specific regulations, such as residential buildings, public buildings, accommodation facilities and tower blocks, with the LEPIR II test. The CSTB facility has specific equipment to test the fire behaviour of façades on buildings subject to specific regulations. French regulation IT 249 on fire safety in public buildings did not previously consider manufactured stone veneer cladding. A solution of this type was tested for the first time in France.

CSTB - LEPIR 2 - Propagation of fire outside façades for buildings subject to specific regulations (residential buildings, public buildings, tower blocks) - FRANCE August 2018

The LEPIR II test involves setting fire to a façade fitted to a structure with two floors. The source that ignites and propagates the fire is on the ground floor and the progress of the fire is controlled through openings in the rear room wall. The temperature and radiant energy are measured. The ETAG 004 procedure is used to fit 20-cm EPS panels providing external insulation to the wall, which is made of perforated cement blocks 20 cm thick. The Geopietra manufactured stone veneer is then installed using the guaranteed procedure. The window sills are made with Geocover flashing. A panel of rock wool 20 cm thick was inserted at the architrave and jambs of the right window, which was deliberately omitted from the left window to further stress the façade cladding. Two 3-cwt piles of wood were placed on the ground floor in front of the windows, which were open and constituted the flow path propagating the fire. 6 internal thermocouples measured flow path temperatures, and another 14 placed 10 cm from the surface of the wall and distributed vertically over the entire height of the wall, measured the ambient temperature of the façade.

Apart from being a legal requirement, optimising fire safety measures in buildings is important for protecting people and property.

For performing the LEPIR II test was used the guaranteed system **PASSA MASTROSISTEMA** in collaboration with **BORTOLO**

MUROGEOPIETRA ON EPS BEHAVIOR AT FIRE.

1. The fire sources are lit and the initial fumes are released. Right side has rock wool reinforcement above the window.
2. After 1 minute 20 seconds the flames are already engulfing 3/4 of the windows on the upper floor.
3. After 5 minutes the temperature of the façade reaches approximately 800 °C and on the left side (with no rock wool protection) the glazing on the upper floor starts breaking.
4. After 8 minutes the façade reaches the maximum temperature of approximately 1100 °C and flames engulf the left window jambs.
5. After an hour, when all the fire source fuel has been used, it can be observed that the façade has not collapsed or yielded.
6. The fire fighters use strong jets of water to put out the fire, creating considerable thermal shock on the wall, but even when persisting on areas most stressed by the test, no collapse is observed.

Visual inspection after completing the test.

7. The stone cladding was difficult to remove from the left window jamb and architrave. At the crack created through the thermal shock, it can be noted that in the absence of the panel of rock wool, the underlying EPS insulation has sublimed, whereas the guaranteed solution (Technical Manual section 6.21) has contributed to keeping the layers of adhesive, mesh and stone perfectly anchored to the base via the wall plugs.
8. The barrier effect of the rock wool panel was significant in triggering a protective reaction against the flames on the wall, reducing the temperature and preventing the flames from engulfing the frames on the upper floor.
9. The PVC frame on the left window was unable to withstand the fire, allowing the flames to spread inside. Although the right window frame was ruined it withstood the fire, remaining hermetically sealed against the flames and the fumes.
10. It can be observed inside that the cellular cement bricks in the room where the fire propagated literally exploded due to the excessive heat.

murogeopietra on EPS meets criteria for non-propagation of a flame front beyond the next floor level, and is authorised to cover R+2 category public buildings.

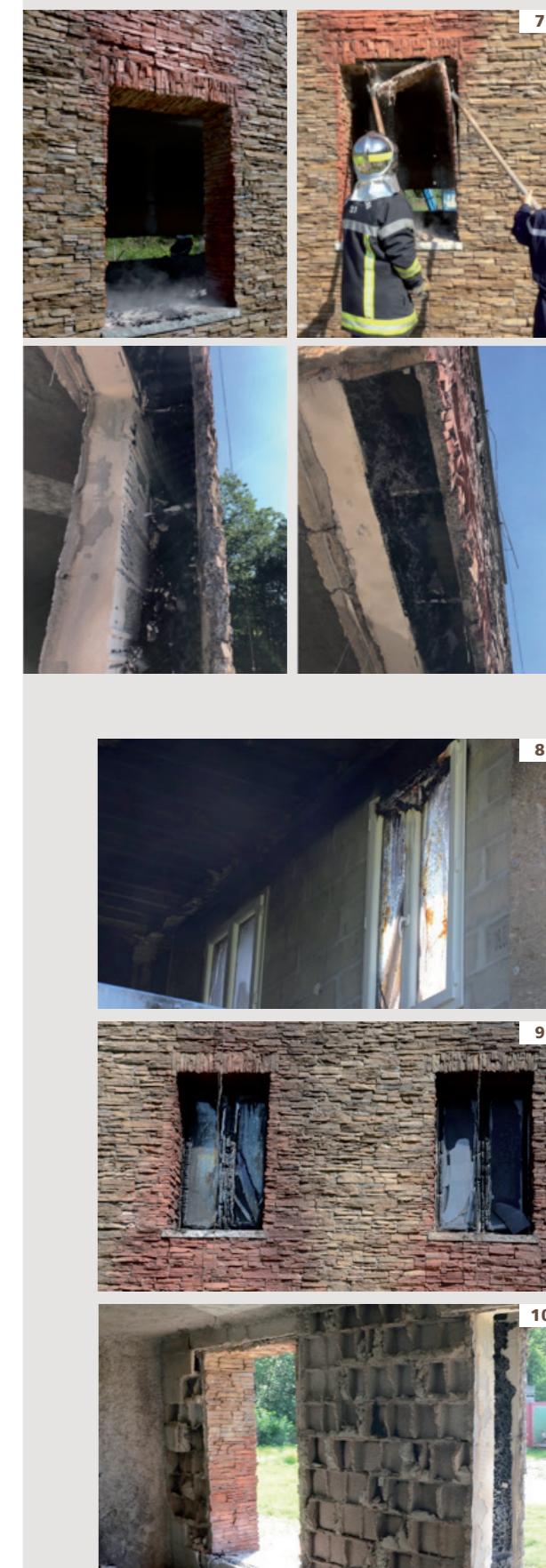

GEOPIETRA®

THE MOST BELIEVABLE MANUFACTURED STONE VENEER IN THE WORLD

GEOPIETRA makes the most believable eco-friendly manufactured stone veneer in the world. **Geopietra®** is a mix of Portland cement concrete, lightweight aggregates and permanent mineral oxide-based colours. The stone is manufactured using natural raw materials only and each stone is coloured by hand with great care and transformed into a product of superior craftsmanship, which is absolutely unique. When installed **Geopietra®** achieves the highest degree of excellence and becomes inimitable.

SHAPES AND SIZES Manufactured stone veneer is available in various shapes, textures and formats, in the sizes of maximum 50x40 cm. Each pattern consists of a series of moulds that are obtained from natural stone parts, all different from each other. For example, pattern P03 Botticino consists of 600 different moulds and is available in 7 shades that can be combined as desired. Each pattern comes with special angle units.

WEIGHT AND THICKNESS Weight ranges from 35 to 50 kg/m², according to the pattern and installation method (with or without grouting), including finishing materials. The stone thickness varies from 2 to 7 cm (5cm on average), while the thickness of manufactured bricks ranges from 1.5 to 3 cm, depending on the model.

PATTERNS AND PROFILES The range of patterns includes 46 different types of manufactured stone veneer, with 6 different MASONRY PROFILES: Ledge stone, Opus Incertum, Square, Spontaneous, Castle and Panel. The collection is complemented with Terrakotta brick slips composed of manufactured brick slips and natural brick slips, with endless combinations.

SHADES Manufactured stone is available in 8 basic shades and some special colours, **all can be mixed together and with any other pattern in the collection**, excluding the Panel pattern and the Castle profile which, due to their shape and colour cannot be mixed. The stone colour in nature is the result of an almost infinite range of hues and shades, similarly numerous variables characterize the colour in the **Geopietra®** collection-from the range of stone shades to installation, from the colour of grout (5 colours and 2 different grain sizes for **GeoBi**) to the grouting method.

FINISHES A great passion for building construction has led **Geopietra®** to venture beyond the simple manufacture of materials, and put their skills into the installation, grouting and finishing techniques. All the products used for **Geopietra®** manufactured stone veneer, such as the specific **Geocoll®** adhesive, the range of **GeoBi** two-component grouting mortar, are the result of technical research and in-field experience.

REFERENCE TESTS

ASTM C150, C595, C989 / ASTM C618 / ASTM C144 / ASTM C33, C330, C332 / ASTM C979

Geopietra® manufactured stone veneer complies with and exceeds the requirements of the US building code: 546T / ICC-ES / ER-3568 - NER-602 / LARR # 25589 / HUD # 910

Tests conducted by TÜV Nederland : NEN-EN 772 / 998 / 494 / 196 / 1050 / 771 / 459 / 197 / 413 / 1339.

DENSITY

in compliance with ASTM C 567 **1200 Kg / m³**

EFFLORESCENCE

in compliance with ASTM C 67:2007

IMMERSION ABSORPTION in compliance with EN 14617 - 1

(%) After 1h	(%) After 8h	(%) After 24h	(%) After 48h
+7,8	+13,7	+14,6	+15

RESISTANCE TO BENDING

in compliance with EN 14617 - 2 **3,7 MPa**

RESISTANCE TO BENDING AFTER 25 FREEZE-THAW CYCLES

in compliance with EN 14617 - 5:2005 **3,2 MPa**

COMPRESSIVE STRENGTH

in compliance with EN 14617 - 15 **21,6 MPa**

THERMAL CONDUCTIVITY FACTOR

in compliance with UNI EN 12667 **0,1866 W/mK**

RESISTANCE TO FIRE Non-Combustible class MO

Flame propagation 0 Fume development 0

in compliance with NF EN 13501-1+A1:2013 **B s1 d0**

murogeopietra on external wall thermal insulation

in compliance with NF EN 13501-1+A1:2013 **A2/B s1 d0**

SOLAR ABSORPTION in compliance with NF EN 410:2011

BT Earth White α 59 / BM Marble White α 60 / LI Lione α 67 / GT Earth Grey α 70 / MT Earth Brown α 81 / GP Pearl Grey α 89. Mortar Geobi MA marche α 48 / Mortar Geobi GR grigio α 60.

Solar absorption affects resistance of adhesive over time. Tests with **Geocoll®** were performed to check the effect. After roughly 15 days of surface heating at 70°C on ceramic samples and **Geopietra** samples in the same shade there was initial tensile strength of 0.9 N/mm², then 0.04 N/mm² was reached with the ceramic and 0.6 N/mm² with **Geopietra**. **The thermal inertia of the geopietra product preserves the strength of Geocoll®.**

COLOUR FASTNESS TO SUNLIGHT Only permanent pigments containing mineral oxides are used. The colour sets after 2-6 months of exposure to weather. No unwanted change of colour is observed, even after years of exposure.

RESISTANCE TO VAPOUR DIFFUSION

average value murogeopietra **μ 26,4**

Overall μ value greater than 60/70 holds too much dampness behind the covering, compromising the structure's insulation.



GEOPIETRA MANUFACTURED STONE VENEER

ADVANTAGES AND POTENTIAL DEVELOPMENT

1. Lightweight. **Geopietra®** manufactured stone veneer masonry is designed to weigh 50-70 kg/m² according to the chosen pattern and installation method, compared to 600-700 kg/m² of natural stone masonry. This property makes **Geopietra®** manufactured stone veneer ideal for cladding lightweight structures, such as coating, plasterboard, cement fibre, wooden panels, insulated sheets and mobile structures.

It does not require any particular embodiments for any types of installation, including sky-high ones, or any particular foundation or specifically reinforced structures.

2. Breathable. The healthy function of the housing envelope is guaranteed by the natural ingredients used and excellent breathability of **Geopietra®** manufactured stone veneer (μ 26.4). The wall breathes, remains dry and allows the natural transition of water condensate.

Geopietra® manufactured stone veneer thus enhances the insulation performance of external thermal insulation systems. The new GeoBi two-component mortar has also been lightened using materials that allow an even surface finishing.

3. Resistance and thermal inertia. Experiments on density and porosity have led to the attainment of a perfect balance between resistance and thermal inertia, which makes this solution ideal for installation on thermal insulation and protection of all types of backing.

Geopietra® manufactured stone veneer inhibits thermal shocks due to sudden climate changes, has very long absorption and release times. Evidence of it is the flammability conducted in **Austria in 2010** at the **IBS** Institute and the recently performed **test Lepir II** conducted in **France in 2018** at the **CSTB** Institute, where EPS insulation panels were protected by manufactured stone veneer. **murogeopietra on EPS meets criteria for non-propagation of a flame front beyond the next floor level**, and is authorised to cover R+2 category public buildings.

4. Low thickness. The thickness of **Geopietra®** manufactured stone varies from 3 to 7 cm, while that of manufactured brick is from 1.5 to 3 cm, according to pattern. Reducing the thickness does not affect the end result in terms of aesthetics, function and sensorial feeling: rather it provides great space-saving both indoors and outdoors, which is a major requirement today.

5. Frostproof. **Geopietra®** manufactured stone veneer is the only product in the European construction industry that can boast 50 years of experience acquired by the parent company, which is tested frost-proof and extensively tested in widely different climates. The technical developments made to make it suitable for installation on thermal insulation systems and the improved weight and thermal resistance have led to an increase in internal micro-porosity, thus creating more space for water expansion when it is transformed into ice. Water absorption has been reduced by a further 20% compared to previous formulations.

6. Colour fastness. Only permanent mineral oxide-based pigments are used for the staining of **Geopietra®** manufactured stone. It takes 2-6 months of exposure to atmospheric agents for the colour to set using a special process. No undesirable change of colour has been noticed even after years of exposure.

7. Eco-friendly. **Geopietra®** manufactured stone veneer is made up of natural ingredients only; it reduces the aesthetic attractiveness of natural stone to a few centimetres, and contributes to reducing the quarrying of natural stone and protecting the environment and landscape. **Geopietra** promotes environmental values and building traditions while pursuing home living comfort and energy efficiency.

8. Functional and quick. **Geopietra®** manufactured stone veneer is simple to use and the consumption of material can be easily calculated without producing waste-it can be laid using a few simple tools. It is delivered in boxes that are easy and quick to handle on site and on scaffoldings. At the end of work, only the boxes and empty adhesive and mortar bags need to be disposed of.

9. Believable and natural. Mould technology, the exclusive ageing system and the manual processing processes contribute to carefully transforming stone into a product of a superior craftsmanship value, which is never the same. **Geopietra®** manufactured stone is available in single units of various sizes. Each pattern comes complete with special angle units that give the wall a 3-D effect, thus producing exactly the appearance of a bearing structure made of natural stone.

10. High aesthetical and emotional value. **Geopietra®** manufactured stone veneer has the ability to convey and express different architectural styles and languages. Thanks to its superior technical features and absolute compatibility with today's building materials and systems, it is highly sought-after for contemporary architectural solutions, by adding character and emotional strength. **Geopietra** offers the possibility of creating a unique work, expressing personal vision of living and creativity. Its beauty bears the sign of the time passing by and accompanies our true innermost emotions.

11. Full of nuances reminiscent of times gone by: the colouring of the meticulous surface finish makes **Geopietra®** manufactured stone veneer truly unique. **Geopietra** has always chosen to replicate not only the hues of natural stone but also its most emotional factor: the passing of time. **Geopietra®** manufactured stone veneer is processed to convey an antique effect by using colours typical of rust and mosses that give the perception of bygone days, a feeling that even newly quarried natural stone cannot give. For the colour to be so unique, it requires an entirely handmade process, which makes it one of a kind, so much so that no two pieces of stone are the same.



murogeopietra plus is the new development at **Geopietra**.
This new installation style is beautiful and convenient in its simplicity.



Observing the natural landscape and unconstrained rural architecture has **produced the SMALL / BIG / SASSO models of special inserts**.

Nowadays, the art of dry stone walling has a key role in architecture, to ensure an authentic reconstruction and the interpretation of tradition with a modern twist.

Using **GeoFit** Geopietra can create the small chips used to fill gaps between stones in dry stone walls. These small stones and rocks collected in the vicinity of constructions provide stability for larger stones in the walls of traditional homes. The detail uniquely characterises wall texture, depending on the resources available in the area.

Geopietra has a new solution made up of various models of **Geopietra + GeoColl + GeoFit**. Combining these 3 elements creates an updated dry stone solution: **murogeopietra plus**.

GeoFit
evolution

plus
murogeopietra



SMALL / BIG / SASSO



By adding **GeoFit** in different shapes, shades and quantities, **murogeopietra plus** is enhanced with detail and small features that make a difference and create harmonious solutions.

The special GeoFit elements make on-site preparation and installation quick and practical.

Furthermore, **the horizontal nature of the design**, uniform texture and visual stability of the stones **are easier to create**.

The shapes and shades of GeoFit simply enhance dry stone structures.

GeoFit
SMALL

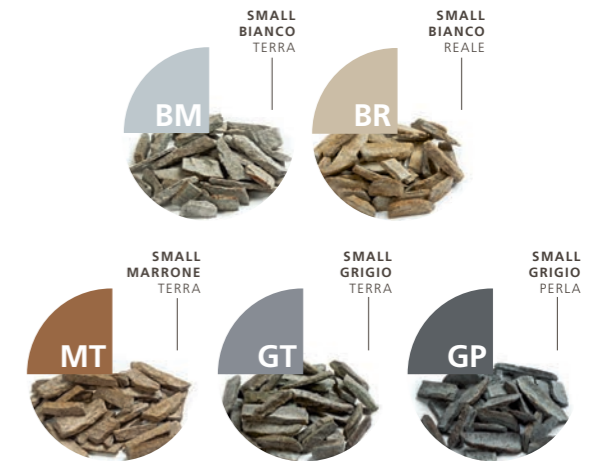

The **GeoFit SMALL** chips have been designed to fill gaps in **murogeopietra plus** arrangements. They are especially convenient to use when installing large pieces, or as a final filler once an installation has been completed. **GeoFit SMALL** is available in 5 shades that match perfectly with the standard colours of the Geopietra models.

SMALL / 1 Box of ~ 100 pieces.
SMALL / 1 Box of ~ 50 pieces.

These are not expressed in areas covered due to their small dimensions.

GeoFit
BIG



The **GeoFit BIG** inserts have varying lengths and sizes. They speed up the **murogeopietra plus** installation process and simplify the formation of the natural horizontal design. Available in 4 colour blends, **GeoFit BIG** matches the Ledge Stone and Spontaneous profile models perfectly, and some Square profile models.

BIG / 1 Box of ~ 50 pieces.
Area of ~ 0.29 m2 with dry laying.
Area of ~ 0.41 m2 with joint technique.

BIG / 1 Box of ~ 15 pieces.
Area of ~ 0.08 m2 with dry laying.
Area of ~ 0.12 m2 with joint technique.

GeoFit
SASSO



The **GeoFit SASSO** version completes the dry technique used with irregular-shaped stones with rounded edges. It reduces time required for breaking and rough-hewing stone to suit small grooves. Available in 4 colour blends, it was designed for random Opus Incertum profile and combined with **GeoFit BIG** in the Spontaneous profile models.

SASSO / 1 Box of ~ 70 pieces.
Area of ~ 0.18 m2 with dry laying.
Area of ~ 0.26 m2 with joint technique.

SASSO / 1 Box of ~ 25 pieces.
Area of ~ 0.06 m2 with dry laying.
Area of ~ 0.09 m2 with joint technique.

new

special pieces

SMALL/BIG/SASSO

plus = Geopietra (+10-20% of material due to the dry-stack installation) + GeoFit + GeoColl

Our **GeoFit** combinations for **murogeopietra plus** are the result of observing traditional dry stone walls. Suggestions have been provided here on obtaining the best results by combining **GeoFit** with various stone models, expressed in number of pieces required per square metre. With its reduced dimensions the **GeoFit SMALL** model is inserted in all murogeopietra plus solutions, regardless of the model selected. The required amount of pieces of the **SMALL** model varies

in relation to the stone design, and is higher for models with long chips and lower for irregular round models. The **BIG and SASSO** models are the most substantial addition in the random Opera and Spontaneo profiles.

For solutions with joints, the GeoFit SMALL pieces should not be ordered as they are too small.

Legend for GeoFit types and colors:

- SMALL: BT (Bianco Terra), BR (Bianco Reale), MT (Marrone Terra), GT (Grigio Terra), GP (Grigio Perla)
- BIG: BM (Bianco Marmo), B (Bianco), G (Grigio), M (Marrone)
- SASSO: (No specific legend provided)

GeoFit / type, quantity of pieces ~ and colour per m² by model.

profile	SMALL	BIG	SASSO	SMALL	BIG	SASSO	SMALL	BIG	SASSO
DEVERO P90	4 / GP	4 / G							
MODERNO P78	GC 15 / BT 3 / G			GS 15 / GP 3 / G			M 15 / MT 3 / G		
PICEDO P39	LM 4 / GT 6 / G			FI 4 / GT 6 / G					
TOCE P19	BM 15 / BT 5 / B			BT 15 / BT 5 / B			GT 15 / GT 5 / G		
	GP 15 / GP 5 / G			BR 15 / BR 5 / B			MT 15 / MT 5 / M		
	MC 15 / MT 5 / G			O1 15 / MT 5 / G					
VALDOSTANO P76	G 10 / GP 4 / G			GC 10 / GP 4 / G			GS 10 / GP 4 / G		
VERSILIA P86	10 / BR 3 / G 4 / G								
VESIO P29	O1 6 / GP 5 / G			O2 6 / BT 5 / BM					

profile	SMALL	BIG	SASSO	SMALL	BIG	SASSO	SMALL	BIG	SASSO
BOTTICINO P03	BM 4 / BT 10 / BM			BT 4 / BT 10 / B			GT 4 / GT 10 / G		
	GP 4 / GP 10 / G			BR 4 / BR 10 / B			LI 4 / BR 10 / B		
	MT 4 / MT 10 / M								
LAVONE P04	BT 6 / BT 4 / B			GT 6 / GT 4 / G			MT 6 / MT 4 / M		
MASO P83	5 / GT 4 / G								
MORSONE P37	SA 8 / BR 4 / B			LM 8 / GT 4 / G			TO 8 / GP 4 / G		

profile	SMALL	BIG	SASSO
SQUARE			
ALBERESE P88	6 / BR	4 / B	
BADIA P84	6 / GT	5 / G	2 / M
GARDA P81		4 / B	
VIRLE P80	10 / BT	6 / BM	



BOX GEOFIT

profile	SMALL	BIG	SASSO	SMALL	BIG	SASSO	SMALL	BIG	SASSO
ALPE P77	10 / GT	3 / G	4 / M						
BRIANO P91	8 / BT	4 / B	10 / G						
CAMUNA P05	GT 8 / GT 4 / G 4 / G			GP 8 / GP 4 / G 4 / G			BR 8 / BR 4 / B 4 / B		
	MT 8 / MT 4 / M 4 / M			O1 8 / MT 4 / G 4 / M			O3 8 / MT 4 / G 4 / G		
	AR 8 / GT 4 / G 4 / G								
CASCATA P06	GT 4 / GT 5 / G 6 / G			GP 4 / GP 5 / G 6 / G			MT 4 / MT 5 / M 6 / M		
CHIANTI P89	10 / GT	3 / M	3 / G						
LIGURIA P82	6 / GP	4 / G	3 / M						
MONIGA P31	SA 3 / BR 4 / B 3 / B			FI 3 / MT 4 / G 3 / G			LM 3 / GT 4 / G 3 / G		
ONO DEGNO P75	8 / GP	6 / G	4 / G						
RIVAROLO P87	10 / GT	8 / G							

Example of Geofit calculation for the murogeopietra plus VERSILIA P86 model, wall measuring 70m².

For dry installation, consider a 10% to 20% increase in material depending on the model when ordering, to compensate for the lack of a joint. The total calculated GeoFit area should then be deducted from this increased value.

Example of Geofit calculation

The table shows the following is required per m²:

VERSILIA P86	SMALL	BIG	SASSO
	10 / BR	3 / G	4 / G

- + SMALL 10 pcs / model in colour BR Bianco Reale
- + BIG 3 pcs / model in colour G Grigio
- + SASSO 4 pcs / model in colour G Grigio

We continue with the calculation:

SMALL 10 pcs x 70 (m²) = 700 pcs (SMALL ~ 100 pcs / box)
700 pz ÷ 100 pz = 7 boxes in colour BR
 GeoFit SMALL pieces are not expressed as areas as they are used to fill gaps between stones.

BIG 3 pcs x 70 (m²) = 210 pcs (BIG ~ 50 pcs / box)
210 pcs ÷ 50 pcs = 4 boxes in colour G
 1 box of GeoFit BIG creates an area of ~ 0.29 m²
 0,29 m² x 4 (no. of boxes) = **1,16 m²**

1,16 m² sqm to be deducted from the order for the flats, model VERSILIA P86, already increased of the necessary % amount due to the dry-stack installation.

SASSO 4 pcs x 70 (m²) = 270 pcs (SASSO ~ 70 pcs / box)
270 pcs ÷ 70 pcs = 4 boxes in colour G
 1 box of GeoFit SASSO creates an area of ~0,18 m²
 0,18 m² x 4 (no. of boxes) = **0,72 m²**

0,72 m² sqm to be deducted from the order for the flats, model VERSILIA P86, already increased of the necessary % amount due to the dry-stack installation.

INSTALLATION WITH JOINTS + GeoFit BIG and/or SASSO

Consider to order about **20%** of the amount of GeoFit BIG and/or SASSO calculated for murogeopietra plus (except for the pieces of GeoFit SMALL) in the mentioned colours.

new



GEOCOVER

geocover
SPACCO



THICKNESS
5,5/6 cm

Geocover is the innovative coping designed by Geopietra. As with murogeopietra, the wall cap SPACCO provides the aesthetics reminiscent of days gone by too.

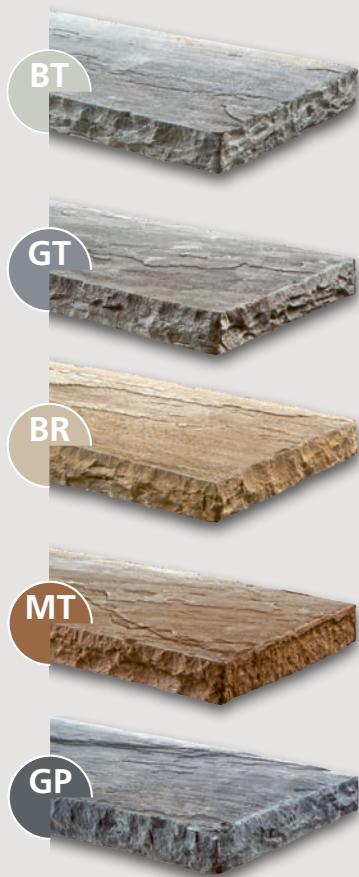

AVAILABLE SIZES
geocover SPACCO
length 100 cm and
thickness 5,5/6 cm, with
6 width sizes available.

The wall caps and the
column head are available
in 5 different shades and
processing
splitted on 4 sides.

100	31
	36
	41
	46
	51
	56

geocover
SPACCO

The **model SPACCO** shown here, (where spacco literally means cut), takes its name from the typical process performed to chisel out the edges, whereas the surface has a natural finish. The mixture for **geocover** wall caps is made up of contains selected rock granules and high-resistance cement with additives, reinforced with fibre glass. **geocover SPACCO** offers the sophistication and authentic appearance typical of the **Geopietra** style. The cut of the natural stone and its finishing have been reproduced perfectly.

The 5 colours available are designed to match perfectly with the wide range of murogeopietra shades.

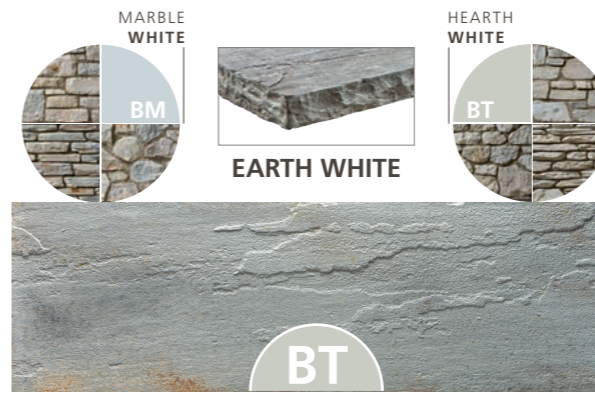

GEOCOVER SPACCO/BT is recommended with the murogeopietra **BM** and **BT** shades



GEOCOVER SPACCO/GT is recommended with the murogeopietra **GT** shades



GEOCOVER SPACCO/BR is recommended with the murogeopietra **BR** and **LI** shades

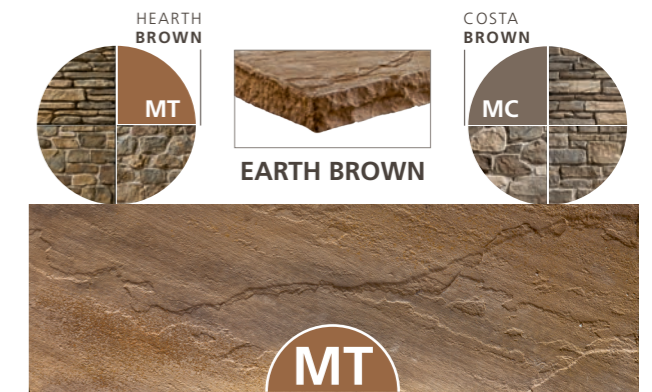

GEOCOVER SPACCO/MT is recommended with the murogeopietra **MT** and **MC** shades



GEOCOVER SPACCO/GP is recommended with the murogeopietra **GP** shades

C O P I N G		cm	kg
31 x 100 cm	COP31 / BT / BR / GT / MT	5,5/6	46 ~
36 x 100 cm	COP36 / BT / BR / GT / MT	5,5/6	53 ~
41 x 100 cm	COP41 / BT / BR / GT / MT	5,5/6	60 ~
46 x 100 cm	COP46 / BT / BR / GT / MT	5,5/6	67 ~
51 x 100 cm	COP51 / BT / BR / GT / MT	5,5/6	73 ~
56 x 100 cm	COP56 / BT / BR / GT / MT	5,5/6	82 ~

C O L U M N H E A D		cm	kg
31 x 31 cm	TES31 / BT / BR / GT / MT	5,5/6	15 ~
36 x 36 cm	TES36 / BT / BR / GT / MT	5,5/6	19 ~
41 x 41 cm	TES41 / BT / BR / GT / MT	5,5/6	25 ~
46 x 46 cm	TES46 / BT / BR / GT / MT	5,5/6	31 ~
51 x 51 cm	TES51 / BT / BR / GT / MT	5,5/6	38 ~
56 x 56 cm	TES51 / BT / BR / GT / MT	5,5/6	46 ~

Before installing Geocover copings please follow the indications suggested in Chapter 3, page 35 about base waterproofing.

The wall cap should be at least about 6 cm wider than the wall completed.

1 | GENERAL INFORMATION

This technical Geopietra manual outlines information and situations that correspond to the skill and practical experience we have gained on building sites over 20 years. The aim is to provide useful instructions, however fitters have full liability for any final choices made. Each site contains too many variables to enable a one-size-fits-all approach, and a reliable solution can only be obtained following an on-site inspection and careful assessment by a professional.

The material for each order undergoes three quality checks before being dispatched, however it is still advisable to check that the model, colour and quantity correspond to details on labels and delivery notes on receipt of the goods. Packaging should be intact at the time of delivery and have no signs of tampering or breaks in the package seals. It is the retailer's responsibility to check packaging is intact on receipt of the goods and to note any issues on the delivery note, which should be countersigned by the transporter as specified in the terms and conditions of sale outlined with the price-list.

Customers have a week following delivery to highlight any issues, after which the material is considered as accepted. **The company accepts no liability for partially or fully installed material.**

Material arriving on sites must be stored out of the reach of possible knocks or damage caused by vehicles and operators. Geocoll® adhesive and GeoBi mortar must be stored in rooms away from bad weather and dampness, which could cause them to harden.

Given that these are quality materials they should be treated with care. The company checks the contents of supplies thoroughly on their departure and disclaims all liability for any shortages during transportation that have not been verified and acknowledged by it.

Temperature and humidity changes, in addition to the manual completion of the stone manufacturing process, may lead to shade variations, as usually occurs with natural stone. It is advisable to purchase required amounts in batches, always considering walls from edge to edge and the mixing of the various pallets and boxes during installation. You should pay attention to Terrakotta bricks too, since they are made of natural clay and present typical shades of the ageing, and they can therefore undergo the same variables of natural stone.

In accordance with Italian legislation and article 1667 of the Italian Civil Code, installers must provide customers with a two-year warranty against installation flaws and, in accordance with article 1669 of the Italian Civil Code, a ten-year warranty against serious installation defects.

At a European level, installers are also responsible for installation faults on the basis of legislation in force in the country where the material is installed.

Geopietra® accepts no liability for the colour of additions or finishes after a period of time. It is unlikely for finishes to be the same as when laid after several years, as a result of natural ageing due to atmospheric agents and the deposit or absorption of dust.

It is advisable to choose and reserve a product well in advance before it is to be used, in order to receive the goods in one batch in good time.

1.1 LIMITS OF USE

- Geopietra® does not increase the sturdiness of walls where it is used.
- When fitting cupboards or similar to walls covered with Geopietra® ensure they are secured to the loadbearing structure.
- murogeopietra does not act as a barrier against rain. Bases must be suitably prepared before installation. (see section 3).
- Prevent water infiltrations between the base wall and the wall covering using coping, flashing, caps and waterproofing. (see section 3)
- Do not use on areas with running or dripping water or slush containing salts or other chemical substances used to melt snow and ice. Dripping or running water can mark the material; if it is unavoidable, treat the wall covering when completely dry. (see section 15)

- **If installed in marine areas** where the wind could transport salt deposits onto coverings, waterproof first when completely dry (see section 15).
- **Chlorine and other chemicals can discolour Geopietra®** manufactured stone veneer, therefore it is not recommended for use in swimming pools to mark lanes and edges.
- **murogeopietra** has only been designed for vertical assembly, therefore it is not suitable in horizontal installations for flooring, wall coping etc.

IMPORTANT

1.2 INITIAL APPEARANCE OF THE MATERIAL

Geopietra® only uses natural products and unique manufacturing technology, making it possible to guarantee manufactured stone veneer for 50 years.

It is then packed while **still damp** in special waterproof packaging with chemical hardening, development and colour setting processes which are still in progress.

These processes continue for several months and are only completed after installation, **therefore when the material arrives on site shades will appear dark** and then become lighter after exposure to the atmosphere.

(see photographs at side).

The long drying process is crucial for the characteristics of the product and to set the colour.

NB. The material is dispatched on pallets in secure waterproof packaging. During hot weather internal humidity may cause a slight bloom on packaging, however this will not damage the stone in any way and will disappear on opening the boxes.



2 | MATERIAL CALCULATIONS

MATERIAL CALCULATION FOR ONE COLUMN

$$A \times H \times 2 = X \text{ m}^2$$

$$B \times H \times 2 = Y \text{ m}^2$$

$$X + Y = E \text{ m}^2$$

total area

$$H \times 4 = Z \text{ m}$$

total CORNER pieces to order

$$Z \times 0,25 = D \text{ m}^2$$

equivalent CORNER pieces in m²

$$E - D = F \text{ m}^2$$

total FLAT pieces to order

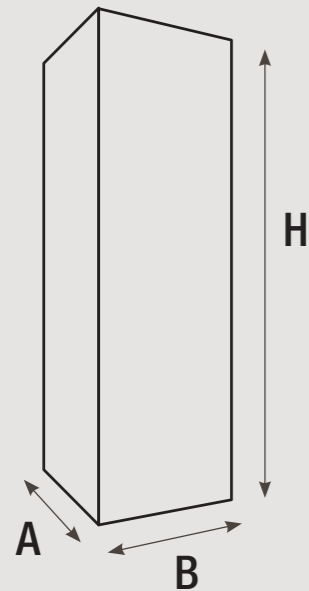

NO

YES



10 cm

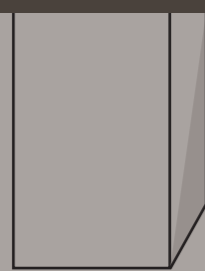

≥ 25 cm

The stones and various models are distinguished as follows on the basis of the installation procedure:

1. Stones and bricks installed with joints (GeoBi finish).
2. Stones installed without joints (dry-stack installation).

This characteristic is outlined in the catalogue and price-list corresponding to each model. However some models which have been designed for installation with joints can be dry-stacked and vice versa.

To simplify the ordering procedure, materials with joints are packaged and sold with this space included, whereas the others are sold without spaces between the stones. Consequently it is sufficient to indicate the measurement of the areas to be covered (m²)* and the height of edges (lm)* without carrying out complex calculations to allow for waste.

The joint dimensions calculated in the assembly are 1.5/2.5 cm for the stone. If normally jointed models are to be installed using the dry-stacking technique, increase the amount of material by 10-20% when ordering, to compensate for the lack of joints.

For the **MUROGEOPIETRA PLUS (dry laying)** models, when ordering, consider a 10-20% increase in material, calculate the required number of **GEOFIT chips** to add and subtract their area from the order of only Flat pieces. **INSTALLATION WITH JOINTS + GeoFit BIG and/or SASSO** Consider to order about 20% of the amount of GeoFit BIG and/or SASSO calculated for **murogeopietra plus (except for the pieces of GeoFit SMALL)** in the mentioned colours. (see pages 16/17)

The joint dimensions for **BRICKS** with a height of 4 cm is 0.8 cm, 1 cm for bricks with a height of 5/5.5 cm and 1.5 cm for bricks with a height of 6/6.5/7 cm

As packaging is carried out manually and the product has irregular shapes and sizes, there may be slight differences in boxes amounting to +5%, therefore it is advisable to purchase a small percentage extra to allow for any waste on site.

*Each item has two types of feature: **Flat and Corner pieces**. **Flat pieces** are installed on vertical walls and ordered by the **square metre**. **Corner pieces** are installed on corners and are ordered by the **linear metre**. Installing corner pieces around openings for windows, doors and columns helps to give the impression of depth and three-dimensionality, accentuating the design of the finish.

N.B. quantities ordered should be rounded up to the box for Flat pieces and 0.5 lm portions for Corner pieces. As per price-list.

It is advisable to cover **columns or partition wall arches** that have sides which are at least 25 cm long, in order to give the element substance and create an authentic appearance. In the case of smaller dimensions, columns can be 'enlarged' using insulation polystyrene at a suitable thickness and with mesh fibreglass reinforcement.

1. MULTIPLY THE BASE BY THE HEIGHT OF THE SURFACE CONCERNED TO GET THE TOTAL NUMBER OF SQUARE METRES FOR THE PROJECT.

2. SUBTRACT THE AREAS OF DOORS AND WINDOWS FROM THE TOTAL PROJECT SURFACE TO GET THE TOTAL NUMBER OF SQUARE METRES TO BE COVERED.

3. CALCULATE THE REQUIRED METRES OF CORNER PIECES BY MEASURING THE HEIGHT OF EDGES TO BE COVERED WITH CORNER PIECES, INCLUDING DOOR

AND WINDOW OPENINGS.

4. CALCULATE THE SQUARE METRES REQUIRED FOR FLAT PIECES. SUBTRACT THE EQUIVALENT IN SQUARE METRES (X 0.25) FOR THE AREA OCCUPIED BY CORNER PIECES FROM THE TOTAL SQUARE METRES TO BE COVERED.

0,25 = average area occupied by 1 lm of corner pieces expressed in m²

1

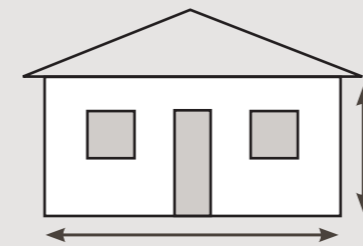

2

SQUARE METRES FOR THE PROJECT

− SQUARE METRES FOR WINDOWS AND DOORS

= SQUARE METRES TO BE COVERED

3

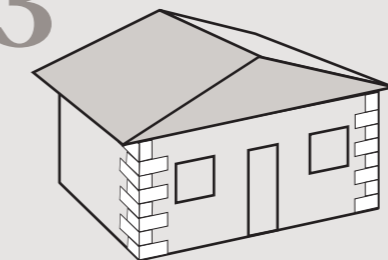

METRES OF CORNER PIECES TO ORDER

4

SQUARE METRES TO BE COVERED

− METRES OF CORNER PIECES ORDERED (x 0.25)

= SQUARE METRES OF FLAT PIECES TO ORDER

always plan a small percentage extra to allow for waste etc.

AVERAGE CONSUMPTION OF GEOCOLL ADHESIVE:

STONE	
STONE INSTALLATION	9 / 10 kg / m ²
INSTALLATION of STONE CORNERS	4 / 5 kg / ml
CORRECTION DIFFERENT THICKNESS	12 / 13 kg / m ²

BRICK	
BRICK INSTALLATION	6 kg / m ²
INSTALLATION of BRICK CORNERS	2 kg / ml

GEOBI GROUTING MORTAR TWO-COMPONENT A+B KIT COVERAGE

STONE	depth	coverage
NORMAL JOINT	2 cm	4 m ²
FULL JOINT	5 cm	2,5 m ²
OVERGROUT JOINT	>5 cm	1,5 m ²
TOUCH-UP for DRY-STACK	-	20/30 m ²

BRICK	depth	coverage
NORMAL BRICK JOINT	1,5 cm	5 m ²
OVERGROUT BRICK JOINT	2,5 cm	4 m ²
MR02 PADANO: NORMAL JOINT	2 cm	4 m ²
MR02 PADANO: OVERGROUT JOINT	3 cm	3,3 m ²

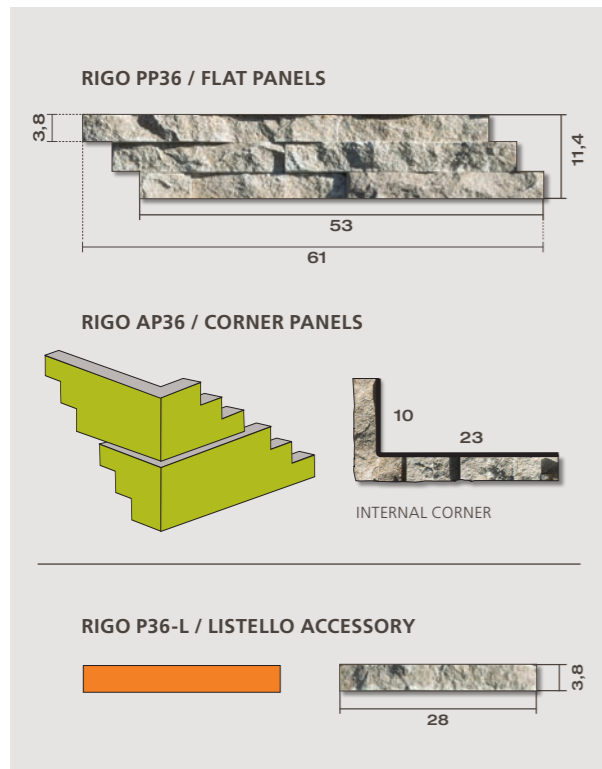

2.1 MATERIAL CALCULATION FOR LISTELLO RIGO

RIGO consists of precision-cut ledge stones molded into panels measuring 11,4 cm x 61 cm, assembled into tightly stacked ledge pieces with varying surface heights and lengths. The panel stair-stepped edges create a tight fit, eliminating unsightly vertical joints. Beveled backsides keep mortar contained for a cleaner and tighter dry-stack installation.

The special profiling on the sides of this model make it modular, which would require LISTELLO (STRIPS) in the case of walls between CORNERS.

The Rigo's LISTELLO connects flat panels in case a gap is too small to be fit with full panels.

LISTELLO is used ONLY in uninterrupted rows of panels running between two Rigo corners (for ex. between windows, doors, etc.)

LISTELLO: Height 3,8 cm~ / Length 28 cm~
MINIMUM ORDER LISTELLO PIECES: full box.
PIECES for BOX: 0,75 m² = n° 72 pcs LISTELLO

An example of a calculation and its simple formula is shown.

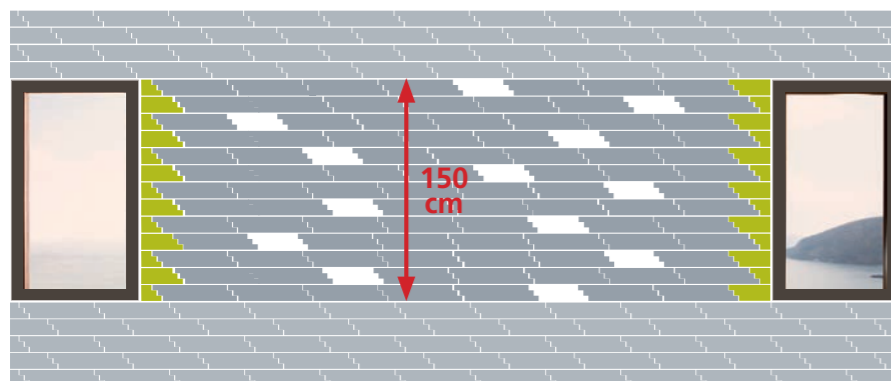

You can proceed as follows:

Install CORNER PIECES first. Install FLAT PANELS along the row from both sides. Run full panels until a gap is too small to fit a full panel. Fill in the remaining gap with the Rigo LISTELLO pieces.

EXAMPLE :
 $\frac{150}{11,4} \times 6 = 79$ Tot. pieces LISTELLO required

H Height (in cm) of wall between RIGO CORNERS / 11,4 Height (in cm) of the flat RIGO PANEL / 6 Max. number of LISTELLO RIGO pieces per row.

Formula for estimating the number of LISTELLO lath pieces to order

$$\frac{H}{11,4} \times 6 \text{ (max. LISTELLO pieces per row)} = n^{\circ} \text{ pcs}$$

Max. number of LISTELLO pieces per row: 6

3 | WATERPROOFING



murogeopietra is not a waterproof wall covering, murogeopietra has been designed for minimum absorbency and maximum breathability features, however the installation base must be prepared correctly to prevent water seeping into walls.

The main cases of infiltration have transpired in relation to the following:

- 3.1 RETAINING WALLS
- 3.2 DOWNPIPE FLASHING
- 3.3 TERRACES: PAVING and PARAPETS
- 3.4 BUILT-IN GUTTERS
- 3.5 END-OF-WALL PROTECTION with FLASHING
- 3.6 DOOR and WINDOW BORDERS
- 3.7 THERMAL PROTECTION with COPING
- 3.8 WALL TOPS in MANUFACTURED STONE

It is very important to put significant focus on water drainage and waterproofing. Water infiltrations can lead to the formation of saltpetre and dampness on walls, affecting the stone in turn. (see photo).





The photograph shows an example of the consequences of water infiltration when the base has not been prepared suitably before installing the wall covering.

murogeopietra is not a waterproof wall covering and cannot be used as protection against water without issues arising.

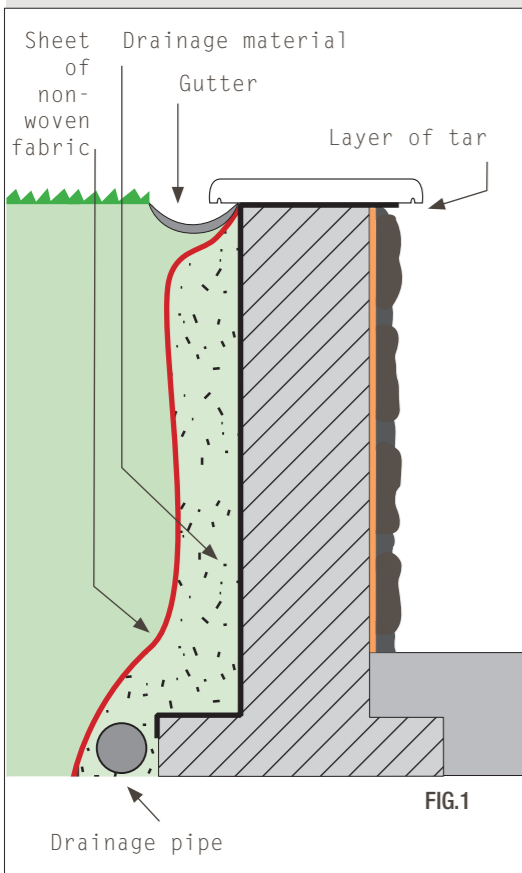

murogeopietra Installation can leave a multitude of wipe marks that are not visible to the naked eye; consider the dry-stack or semi-dry-stack technique in particular - a perfect seal is impossible during grouting.

Note that waterproofing techniques using glazing liquids or other products on wall coverings after installation have not given satisfactory results in terms of performance and watertight over time.

Various suggestions based on experience gained on site have been outlined below, however it should be remembered that the ideal solution can be provided by the manufacturer or waterproofing specialists.

3.1 RETAINING WALLS

Retaining walls must be waterproofed on the inside, in contact with the ground, with a layer of tar extending up the full height of the wall. It is advisable to continue until the outside of the wall is reached, working horizontally until the coat is 3/4 the thickness of the wall, in order to also prevent infiltrations near the adhesive behind the wall covering.

Any stone coping added afterwards may not ensure joints are adequately sealed.

To prevent standing water, insert drainage material behind the wall and a perforated drainage pipe lower down at foundation level. Protect the drainage material from clay soil with a TNT filter to ensure it continues to function. Check there are no areas of standing water on the embankment when it rains, and create a drainage channel if necessary.

Note: Waterproofing the outside of the wall with special materials, such as osmotic cement, could be problematic as the water could still penetrate the wall, collect behind the waterproofing and cause breakage and detachment when it freezes.

The lack of suitable base waterproofing can lead to fairly serious surface dampness issues that can be difficult to treat.

Unfortunately we deal with such problematic situations on a regular basis and have outlined some possible treatment solutions below, without guaranteeing that they will resolve the situation.

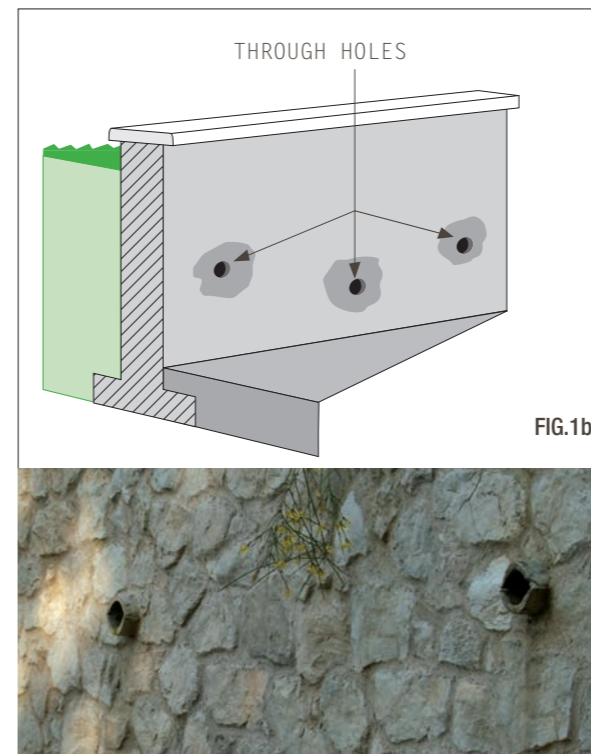

Manifestation of slight dampness.

Strip and clean the base of any impurities by means of abrasive blasting or using a pressure washer, and apply a double layer of Geocoll®.

Manifestation of significant dampness.

In the presence of significant amounts of dampness and localised areas of water behind walls, make through holes for drainage in the relevant areas before gluing the wall covering appropriately in accordance with the gaps (Figs.1a/1b).

Manifestation of extensive dampness.

In irrecoverable situations a false wall must be created with an air gap >3 cm using vertical columns in steel/aluminium and asbestos cement slabs.

Make drainage holes at the bottom and ventilation holes at the top, which should also be included in the wall covering. Apply a double coat of Geocoll® adhesive with Georete fibreglass mesh reinforcement, overlapping by at least 10 cm on corners and joints. Install the stone covering once this has hardened (Fig 1c).

3 | WATERPROOFING

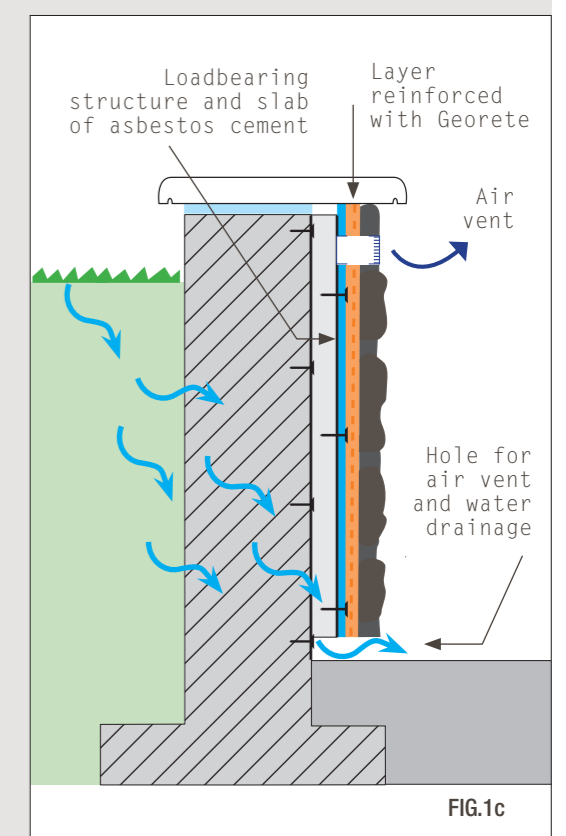
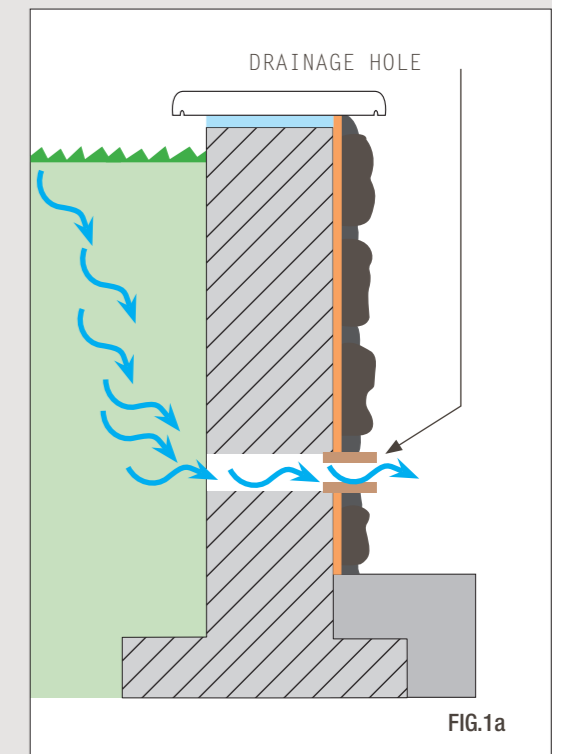

NO



In the picture an example of incorrect installation.

INSTALLATION EXAMPLE ABOVE ROOFING

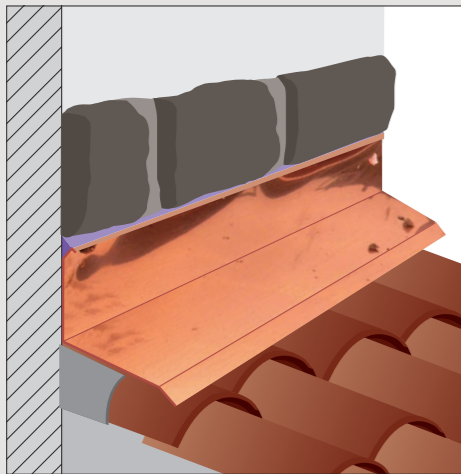

3.2 DOWNPIPE FLASHING

Preventing water from standing and seeping in behind the stone is essential for ensuring the **murogeopietra** stays securely attached to the wall over time. Ensure suitable guttering has been designed correctly to drain away rainwater.

The various types of flashing positioned to protect the point at which the roof meets a wall supporting other underlying roof pitches must always be fitted before the **murogeopietra** covering.

The wall covering, bordering a roofing, can start flush with the flashing after sealing it at one end with silicon, or overlap it on one side using metal mesh or **Georete** fibreglass mesh set in **Geocoll**® adhesive.



NO



In the picture an example of incorrect installation.

INSTALLATION EXAMPLE UNDER ROOFING

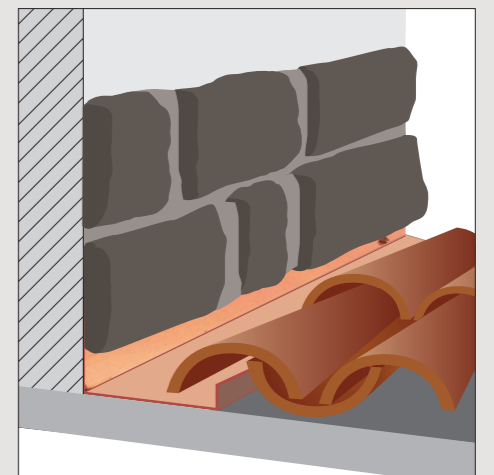
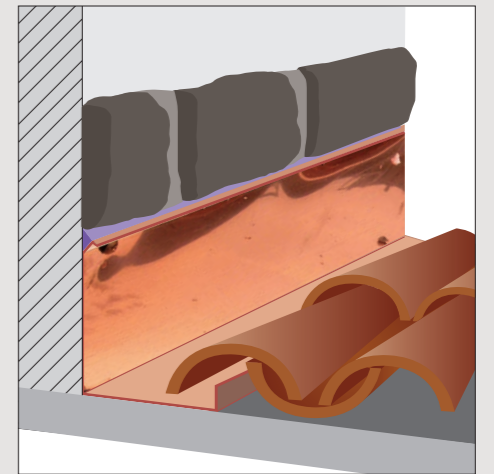

YES

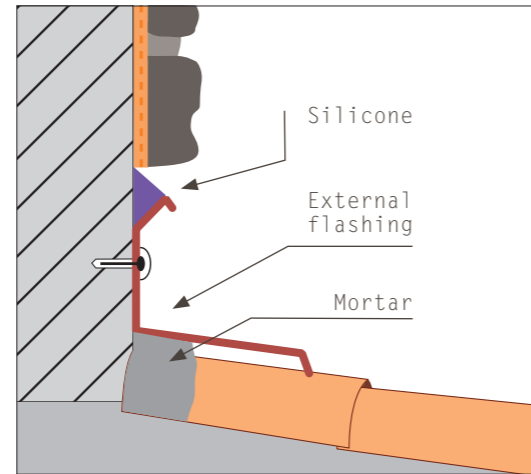

FIG.2c

YES

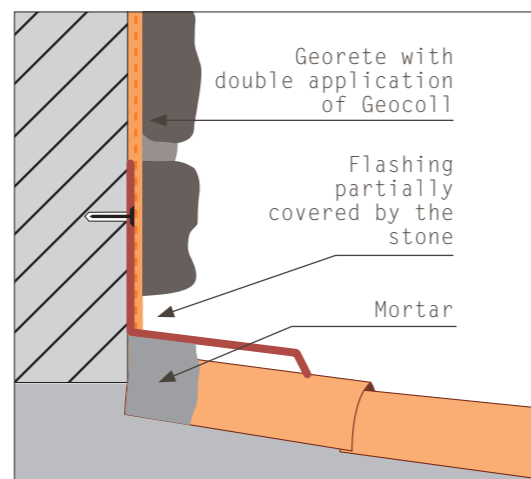

FIG.2d

YES

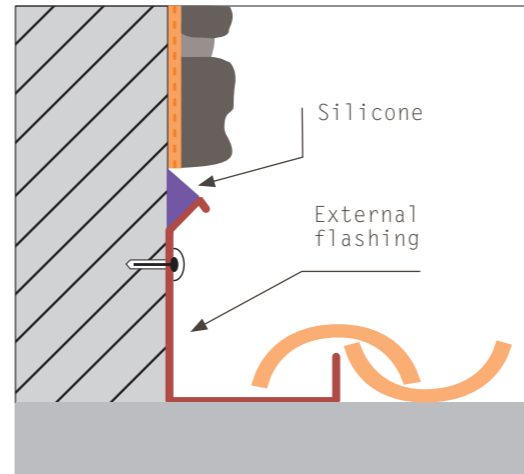

FIG.2a

YES

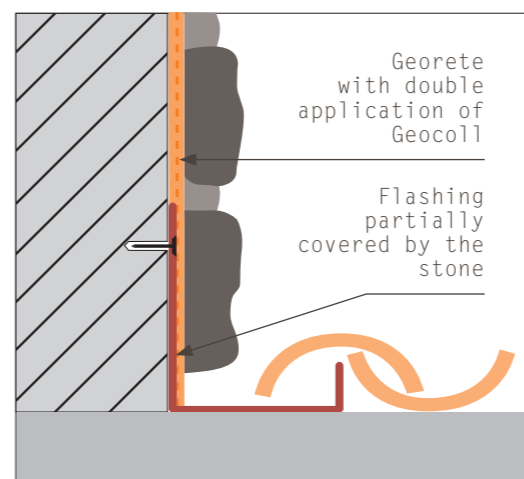
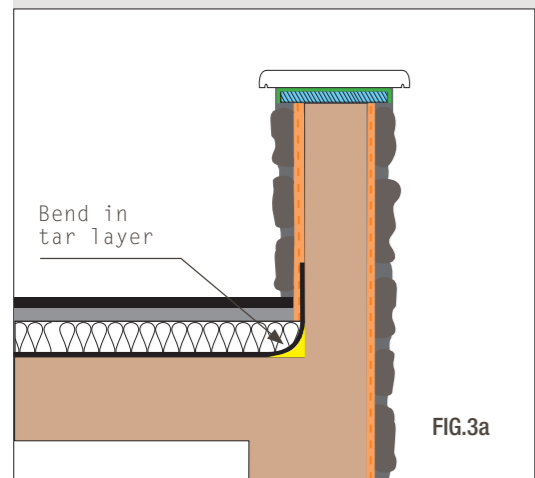
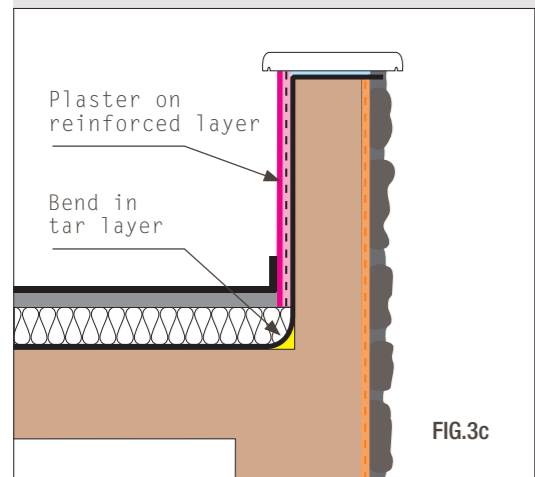
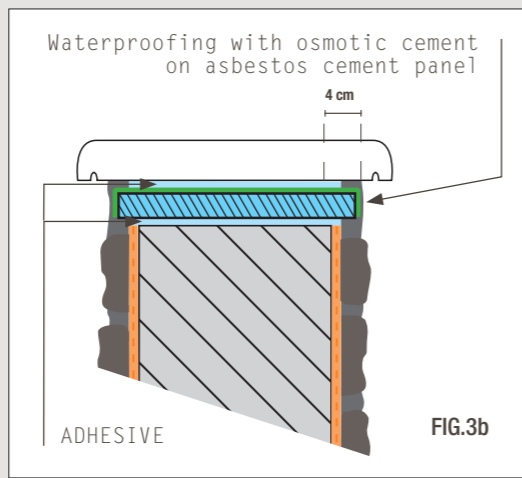

FIG.2b



YES



YES

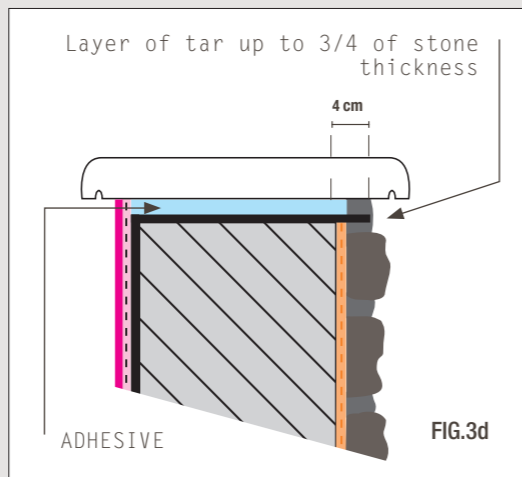

3.3 TERRACES: PAVING AND PARAPETS

Waterproofing terraces can still be the cause of many problems even today. Even though there are reliable tested materials available, the same mistakes continue to be repeated, be it due to poor professional services, cutting corners to save money, or basic negligence.

The following are only a few cases that involve **murogeopietra**:

The tar's critical breaking point is the internal corner therefore this must be offset by filling it out significantly, with it rounded off or set at 45°.

- The tar lip must be over the edge of the skirting in the case where **murogeopietra** is also on the terrace's internal wall (Fig.3a).

- Before installing the stone, finish the head of the parapet by gluing a waterproofed with osmotic cement asbestos panel protruding at least 4 cm over the thickness of the **murogeopietra**, and then cover with coping (Fig.3b).
- in the case of an interior plaster finish it is advisable to waterproof by continuing the tarring of the floor for the entire height of the parapet and proceeding under the cap edge up to 3/4 of the thickness of the **murogeopietra**. The interior plasterwork can be implemented using metal mesh or similar (Fig. 3c).
- The top coping can be glued directly above the layer of tar. (Fig. 3d).



In the photo above A clear case of a terrace with no gutter; this is a common mistake that causes significant aesthetic damage and corrodes the stone.

Figure 3e shows the incorrect installation used in the example in the photo and **figure 3f** shows the ideal solution.

3.4 BUILT-IN GUTTER

Rainwater drainage pipes on roofs or terraces are often built into the structure for aesthetic or practical reasons. Unfortunately, imperfect joints in various sections or the lack of insulation around them to prevent seepage can cause dampness or salts to form on the face, which then appear on the surface of the plaster and the **murogeopietra** (Fig. 4).

Figure 4 shows an example of a possible correct installation.

NO

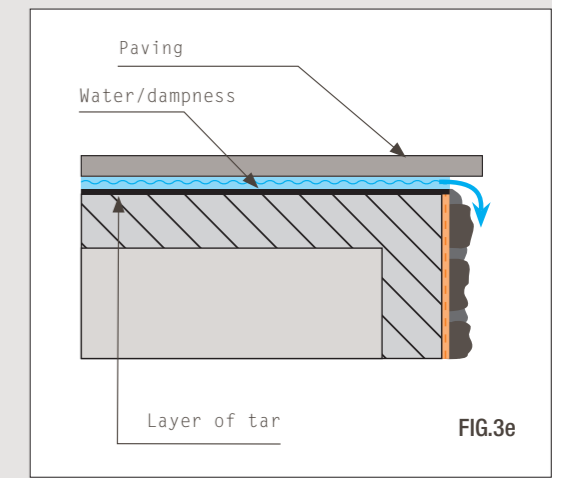

YES

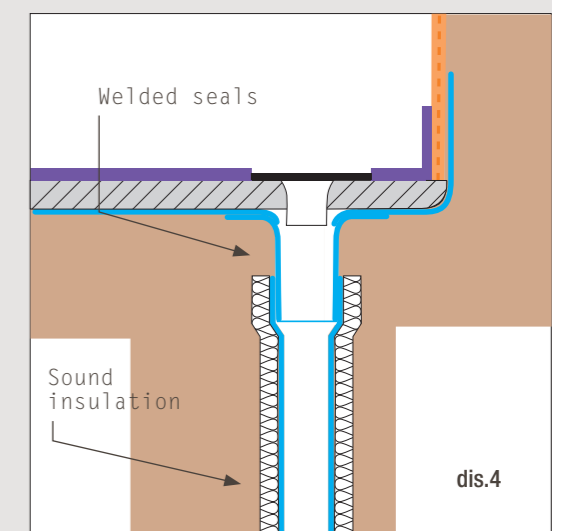
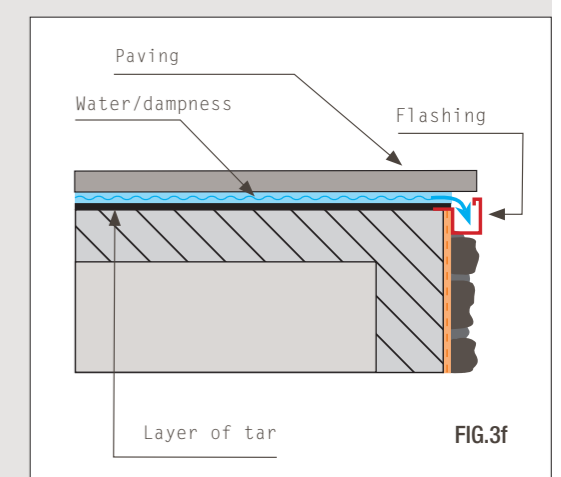

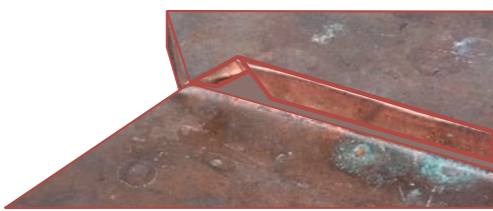

FIG.5a

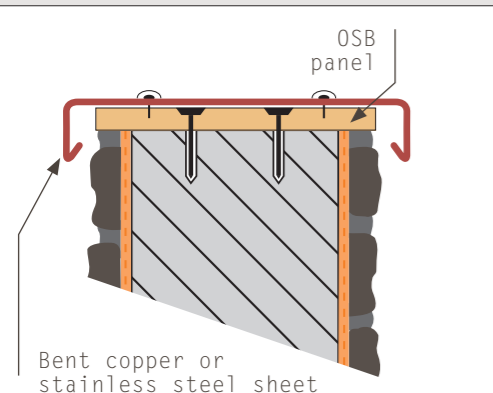

FIG.5b

3.5 END-OF-WALL PROTECTION with FLASHING

Another critical point is the roofing at the end of the wall, which must provide suitable waterproofing protection over the long-term. The best solution is still roofing in stainless steel or copper of suitable shape and size, without the use of silicone or elastomer joints that could come off through time (see examples of finishes in figure 5a).

The sheet roofing will be secured to the top of the wall following the insertion of an OSB wood panel, after having installed the **murogeopietra**. The OSB panel will be secured to the structure using wall plugs in accordance with the required gradients, and flashing secured above it with waterproof screws and special covers to complete the solution (Fig. 5b).

3.6 DOOR AND WINDOW BORDERS

When finishing off doors and windows maximum care must be taken with joints between coverings and the material bordering the opening, where thermal bridges can transpire and thermal expansion can cause cracks.

It is advisable to waterproof the area with special elastic material reinforced with fibreglass before installing the **murogeopietra** (Fig. 6).

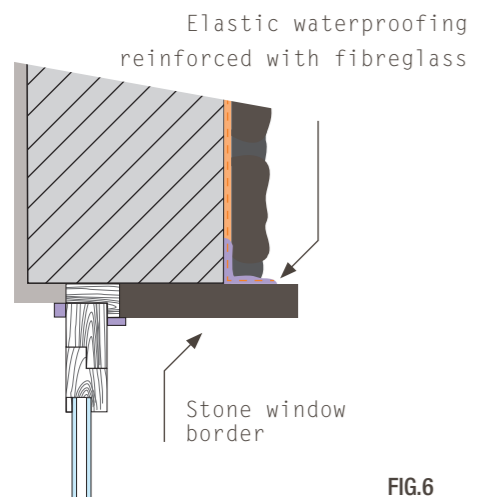

FIG.6

3.7 END-OF-WALL PROTECTION with COPING

Another critical point we have noted is coping at the end of walls, which must also be suitably prepared to ensure long-lasting protection.

The following points must be considered in particular:

1. Water can run horizontally along short sections under the outer edge of coping. A drip edge of suitable dimensions should be fitted to prevent water standing and seeping into the structure.
2. Roofing material (stone or agglomerates) expanding incompatibly with the structure, causing cracks on joints resulting in water penetration. Before installing the stone a horizontal waterproof layer must be applied. For this purpose an asbestos cement panel can be glued to the top of the wall, protruding at least 4 cm from the **murogeopietra** and lying flush with any plasterwork, and waterproofed with paste or cement-based materials and fibreglass reinforcement, enabling subsequent application of adhesive and the coping (Fig.7).

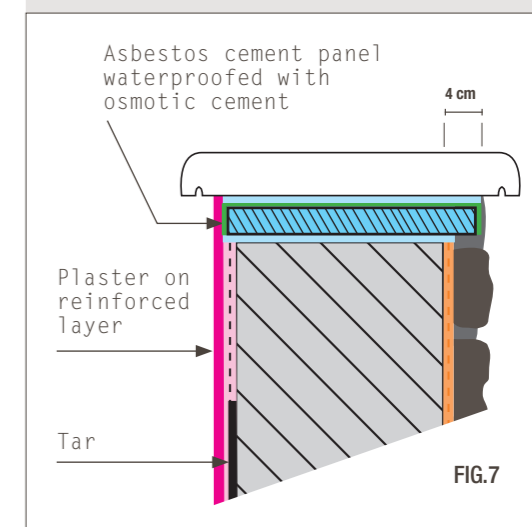
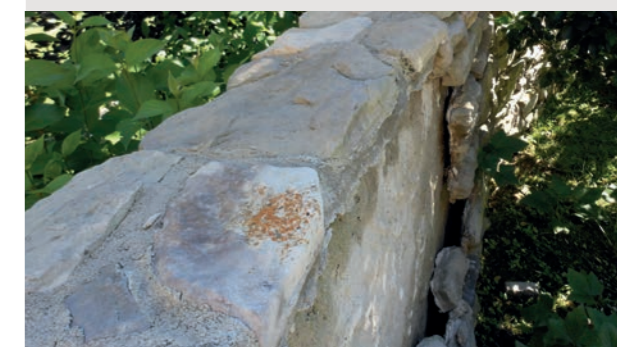

FIG.7

In the photos

Sections detached due to water infiltrations at the top of the wall, generated by the lack of suitable waterproofing.



new

GEOCover S P A C C O



THICKNESS
5,5/6 cm



3.8 THERMAL PROTECTION with GEOCOVER COPING

Experience gained by **Geopietra** in over 20 years of work on sites in Italy and Europe highlighted the need to manufacture accessories to give coverings a suitable finish. **Among these is the innovative GeoCover coping for wall coverings, which is exceptionally strong and frost resistant.**

This is the first in a series of accessories provided for customers to improve the look and functionality of their walls.

GeoCover has been designed to match perfectly with the various colours of the **Geopietra** models, and the new installation system also resolves the issue of water penetrating joints. In terms of dimensions a fixed length of 1 m is available, and varying widths of 31 / 36 / 41 / 46 / 51 / 56 cm, which have been finished on all 4 sides.

Square pillar heads measure 31 / 36 / 41 / 46 / 51 / 56 cm.

Coping and pillar heads are provided with drip edges.

Measurements were chosen by considering walls of width 20 cm, 25 / 30 / 35 / 40 / 45 cm, with the addition of a **Geopietra** covering approximately 5 cm thick with side edging of 3 cm.

If wall measurements differ by multiples of 5 or there is plaster or a petroleum-based coating, having calculated the total with borders, always choose the measurement with a surplus rather than a deficit for maximum protection against bad weather.

Example calculation for selecting the measurement required:

A base wall of 25 cm where a Geopietra covering will be installed on one side only and two edges will be $25 + 5 + 3 + 3 = 36$ cm



On the **Geopietra**  channel watch the video: "Assembly instructions GeoCover"

We all appreciate the importance of preventing water from penetrating walls from above. Numerous methods have been adopted using stone, cement-bonded agglomerates, copper or steel flashing - in all cases the critical point continues to be the joints between the various pieces.

The photographs on the opposite page show the consequences of water that penetrated a joint between blocks of stone. It doesn't matter what material is used for grouting between the various elements - atmospheric agents, thermal expansion and structural movements cause water leakage over time.

The formation of saltpetre and loose plaster or cladding are the usual results of water penetrating walls. While researching and implementing **GeoCover** wall coping, **Geopietra** designed and tested a safe simple solution that solves this problem.

A specially-adapted stainless steel plate at the joints on the back of the product channels water infiltrations from the joint outside the wall and its covering.

This is illustrated below:

It is advisable to fit the coping before wall coverings.

1.2.3.4. For a professional job always level out the support surface using mortar, creating an inclination for water drainage. For example, in the case of an earth retaining wall, water must be drained towards the ground, therefore an inclination of a few millimetres would be required.

5. A kit is provided with the **GeoCover** coping consisting of a **stainless steel plate**, two **adhesive strips** of foam material, and the **screws** required for attachment to the base of the coping, where expansion plugs are already inserted.

6. 7. 8. 9. 10. 11. Remove the protective paper from the adhesive strips and stick them to the edges of the plate. Make holes in the foam to correspond with the screw holes and secure the plate to the base of the coping.

The slots on the plate have been designed to enable the coping to be positioned further than the stipulated edge of 3 cm. In practice, if the installer decides to leave edging of 3.5 cm on one side and 2.5 cm on the other, it will also be possible to move the steel plate; what is important is that the plate covers the wall and the wall covering. Infiltrating water must be drained outside the complete arrangement. The foam strips act as a seal between the steel plate and the coping.

The foam strips act as a seal between the steel plate and the coping.

12. 13. 14. The installation of the coping with a cement-based adhesive requires a double coat.

For approximately 10 cm on the base of the coping, on the side opposite the plate, the adhesive must not be positioned, such that the next steel plate adheres perfectly to the base.

15. 16. 17. 18. 19. 20. The GeoCover coping must be positioned to obtain the side edges required; the thickness of the joints between pieces is usually about 1 cm.

21. 22. 23. 24. 25. 26. The Geopietra piping bag can be used to fill joints. Cover edges and ends with tape to keep the coping clean and speed up finishing operations. Inject the mortar along the entire length and work it as it hardens.

27. 28. Remove the tape and proceed with the installation.

Stainless steel plates cannot be provided in the case of cross cuts with varying lengths.

To address this, a strip of bitumen sheet of suitable width is recommended. Sides can be sealed with a generous amount of acetic silicone or two adhesive strips of expanding foam material.

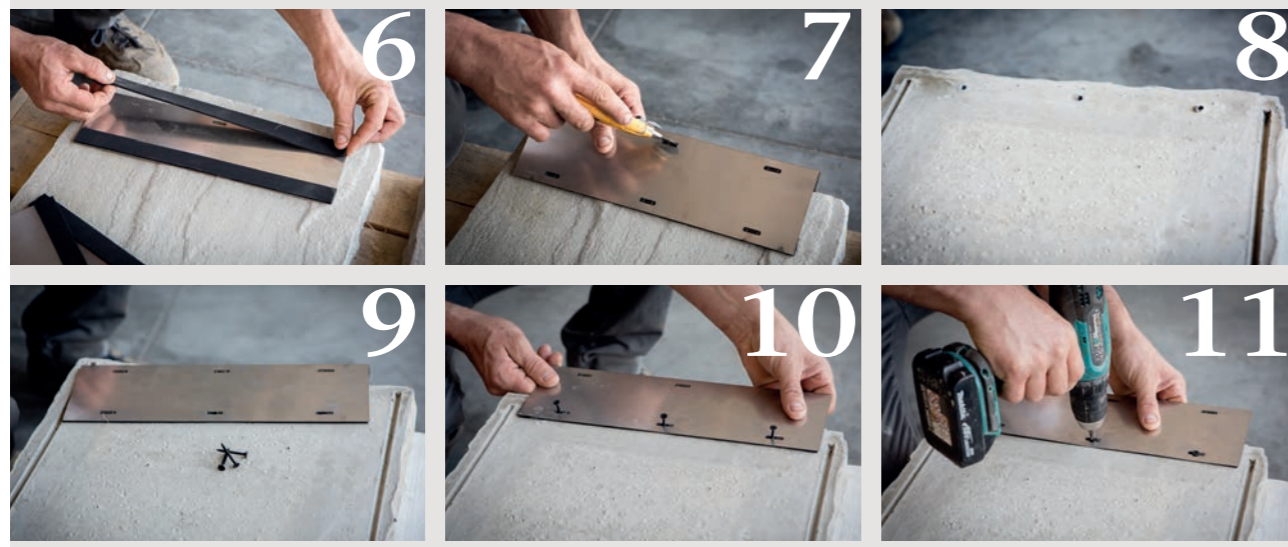



In the photos

Once again the lack of suitable waterproofing has led to water infiltrations over the entire wall and the formation of saltpetre, which caused the surface of the stone to deteriorate after several years.

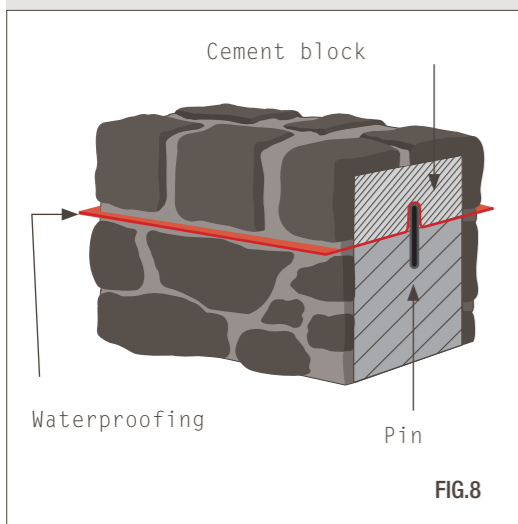

3.9 TOP of WALL in MANUFACTURED STONE

If an external wall completely in manufactured stone veneer is required, without coping or end flashing, the top of the wall must be waterproofed appropriately to prevent water infiltration and detachment.

It is NOT advisable to use absorbent materials such as terracotta or brick for the construction of loadbearing structures with no upper covering.

The recommended procedure is as follows:

1. Seal the top of the wall with a layer of waterproofing that is sufficiently wide to protrude over the sides of the brickwork
2. Cover the material with cement blocks of the same thickness as the underlying wall.
3. Glue corner pieces onto the top and finish with mortar, being sure to leave 1 cm of the waterproofing clear so it can act as a drip feature to remove water from the wall.

Various methods can be used to bind the various parts of the structure, the priority is to avoid creating holes in the waterproofing itself.

Figure 8 shows an example with an iron connection pin.

As Geopietra manufactured stone veneer has not been designed for horizontal use, it may undergo colour changes through time. It is advisable to apply a breathable waterproofing treatment to parts positioned horizontally.

4 | ASSESSMENT OF THE BASE

INSTALLER LIABILITY. The first essential operation the installer must carry out is to assess the characteristics of the base, and understand if it is suitable for the covering to be applied or if it must be prepared beforehand. All detachment issues that have transpired over the years have been caused by incorrect assessment of the base and incorrect use of the adhesive, especially when installing panel solutions. It is the installer who is held responsible for these detachment problems, in accordance with arts. 1667-1669 of the Italian Civil Code.

murogeopietra must always be applied to solid structures constructed in line with professional building practices. **Surfaces where Geopietra® coverings are to be applied must be strong enough to withstand a covering of approximately 50-70 kg/m² (35-50 kg Geopietra, 5-8 kg Geocoll, 8-13 kg GeoBi); in the case of installation on external thermal insulation the manufacturer must guarantee a capacity of 70 kg/m².** In particular the adhesive must be able to bond sufficiently to withstand the stresses that are created between the covering and the structure, without it coming off. Contrary to common belief, **the main problem is not the weight of the stones but the thermal expansion between the various materials**, caused by changes in weather, temperature and drying times. The possibility of detachment increases when two surfaces are not bonded together sufficiently.

4.1 MISTAKES TO AVOID

1. Installation in the presence of paint/varnish. No paint, varnish, surface waterproofing treatment or other finish has the mechanical characteristics to support the stone, being designed to support their own weight only and adapt to structural movements. The application of a wall covering, with thermal expansion characteristics incompatible with the base in the presence of such finishes, will cause it to detach over time.

2. Installation on ready-mixed plaster. There are cement-based ready-mixed plasters on the market with good mechanical strength characteristics that support **murogeopietra** after taking the appropriate measures. Several others exist, which are lime-based or similar, that do not support the weight of the wall covering. Before putting a wall covering directly onto plaster, it is advisable to consult the manufacturer and the installer for case-specific guarantees. Check there is no dust or loose material on the base, which is typical with the final stages with ready-mixed plasters (scratch coat).

3. Installation on a standard skim coat. A standard finish with a skim coat of plaster (or fine mortar), which is lime-based, creates a weak, insubstantial surface similar to paint and without the mechanical strength characteristics required to support wall coverings.

4. Installation with adhesive only applied to the base with a toothed spreader and without a double application. Using

an installation technique similar to a standard tile technique (especially with the P16 and P12 models), where the adhesive is only spread on the base with a toothed spreader will definitely cause the covering to become detached. Absorption between the **Geopietra®** and the base quickly removes the water from the adhesive, blocking the chemical reaction in progress and hampering adhesion to the base.

5. Adhesive not suitably bonded to the base. Applying the adhesive to the feature only and pressing it on the base with light pressure will not ensure secure bonding. **Geopietra®** requires adhesive to be applied using a wet-on-wet technique, ensuring distribution over the entire surface of the feature, and exerting firm pressure with side movements until any excess adhesive is squeezed out and the bond is secure. (suction effect).

6. Installation with high/low base temperatures that overheat/freeze the adhesive. The bonding and hardening features of adhesives occur via the chemical action triggered by the water in the mix. A lack of water blocks the chemical reaction, compromising the hardening procedure and the possibility of obtaining the mechanical characteristics required. A mix which is too hard and base temperatures that are below zero or over 30°C can ruin an adhesive and its ability to set, resulting in detachment over time.

7. Installation on very absorbent surfaces. The same issues outlined in **number 6** can also transpire with a very absorbent base. The rapid removal of water from the adhesive interrupts the chemical hardening action without the required technical characteristics being obtained.

8. Prior application of primers, bonding agents or sealants. There is a mistaken belief that in the presence of unstable bases any issues can be resolved by using bonding agents or sealants. In practice the opposite is true, as they only work on the surface or to a depth of a few millimetres, and do not strengthen the section which is unstable. Even if they acted more effectively, they would still prevent the passage of vapour, potentially causing problems with condensation or causing the wall covering to detach in more serious cases.

9. Installation on non-waterproofed retaining walls. The infiltration of water can cause marks to form on stone and lead to the formation of saltpetre, ruining the material and causing detachment in more serious cases.

GEOReTe

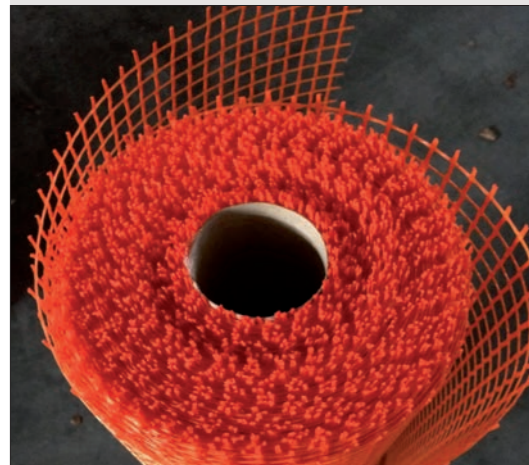
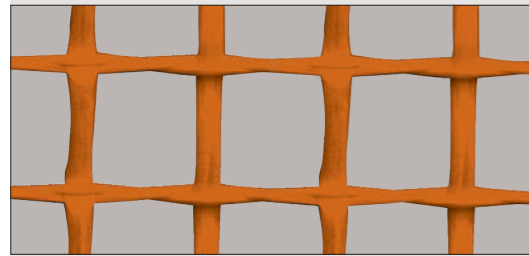

Georete is a special large-mesh fibreglass arrangement with exceptional mechanical strength for use as reinforcement for unstable or insubstantial bases.

With a specific weight greater than 315 g/m² it supports such high tensile loads that it can be used as an alternative to conventional iron mesh.

Georete is used as a support layer in guaranteed solutions for installing Geopietra on external thermal insulation.

Thanks to its high-quality anti-alkaline finish, **Georete** provides excellent resistance against alkalis, whereas the large mesh (15x15 mm) enables the perfect adhesion of the mesh in the adhesive, guaranteeing the integrity of the reinforced layer. Unlike metal products, it also limits the consumption of adhesive, reduces thicknesses, adapts to the thermal expansion of the material in which it is inserted, is not subjected to oxidation, and does not create electromagnetic fields.

DATA SHEET

MESH		15 X 15 mm
No. WIRES	DIN 53854	6/6 Fdn / 10 cm (6*410 tex / 2*900 tex)
WEIGHT	DIN 53854	Dressed mesh 315 g/m ² ± 5%
INGREDIENTS		Fibreglass~ 87% - Alkaline-stable dress ~13%
SHEAR BOND STRENGTH	DIN 53857T1	K/S > 4750/2800 N / 5cm
TENSILE STRENGTH		~ 2% / 5cm
CONSUMPTION GEOCOLL		~ 4 Kg/m ²



WALL PLUG ARRANGEMENT 40X40 mm
AVERAGE COVERAGE 6.37 plugs/m²

GEOtassello

UNIVERSAL WALL PLUGS FOR MECHANICAL ANCHORING
WALL PLUGS complete with PLATE and SCREWS with diameter of 8 mm.

EXTERNAL / INTERNAL USE: stainless steel screws

If using for mechanical anchoring on wood or similar, ask for GEO-PIATTOVITE, plates with stainless steel screws with diameter of 8 mm.

5 | MECHANICAL ANCHORING with GEORETE and GEOTASSELLO

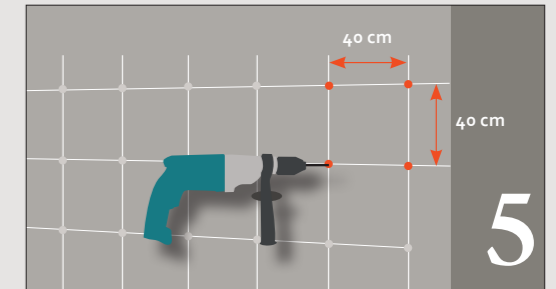

In the presence of critical installation bases with insufficient mechanical strength to support the wall covering, Geopietra experience advises **AGAINST** using treatments or pitting techniques as they cannot guarantee the integrity of the solution over time.

The best solution is **mechanical anchoring** using a layer of **Geocoll**® adhesive with a minimum thickness of 3/4 mm, in which special reinforced **Georete** fibreglass mesh can be embedded and secured to the loadbearing structure using stainless steel (external use) or galvanised (internal use) **Geotasselli** wall plugs.

1. Using a smooth trowel apply a layer of **Geocoll**® adhesive which is 2/3 mm minimum and of reasonably soft consistency (8.5-9 litres of water per 25-kg bag). With very absorbent bases dampen them first then apply the layer when there is no film of water remaining.

With dirty or deteriorated bases clean or remove fragile parts.

2. Embed the **Georete** fibreglass mesh, overlapping the joints by at least 10 cm and turning on corners to make the wall compact and counteract the stresses created at corners.

3. Apply a second layer of **Geocoll**® immediately, covering the mesh completely.

4. 5. 6. Use a drill with a bit diameter of 8/9 mm to create a 40x40 cm grid corresponding to 6.37 wall plugs per m² and insert the **Geotasselli** wall plugs, ensuring they are held firm and removing and replacing any that are loose.

7. Cover the heads of the plugs with a layer of **Geocoll**® to prevent water seeping into the structure.

8. Install the **murogeopietra** only once completely dry (minimum 2 days).

6 | PREPARATION OF THE BASE

murogeopietra can be applied directly to untreated rough walls, on any kind of mortar with good mechanical characteristics and on appropriately secured insulation. Special base preparation procedures must however be carried out for wood, metal, plasterboard, reinforced concrete, foam concrete, weak plasters, and painted or treated surfaces before installing the wall covering.

These instructions are the result of numerous tests carried out and experience gained on site over the last 20 years.

6.1 BRICK

Even though this base is suitable for anchoring purposes, direct installation on brick will not guarantee protection against rain, which could saturate the wall and lead to serious dampness inside. The Geopietra covering should not be viewed as a waterproofing layer and in the case of a dry installation technique it may even lengthen the time taken for water to drain. Another issue with this base is its ability for absorption, which could soak up the adhesive when fitting the covering.

To avoid these issues, in the presence of vertical walls with upper covering, apply a coat of waterproof plaster with suitable mechanical characteristics to the thickness recommended by the manufacturer (see also sections 6.5 and 6.6).

6.2 BLOCKS OF FOAM CONCRETE (e.g. Gasbeton or Ytong)

To make the wall uniform and improve resistance against water, apply a minimum 5-mm thick reinforced layer using the adhesive recommended by the foam concrete manufacturer, with high-strength fibreglass mesh embedded, such as Georete. Drill holes and secure the assembly using special wall plugs (cat. E) positioned in a grid no larger than 50x50 cm (i.e. minimum 4 wall plugs/m²) ensuring that the plug heads are covered with the adhesive to prevent water infiltrations. Only install the covering once this layer is dry.

6.3 REINFORCED CONCRETE (R.C.)

This is one of the most stable bases but it is also one of the most difficult to work with. Consider the following in particular:

- Only install on reinforced walls that have been left to set for **at least 3 weeks**.
- If release agents have been used to remove formwork, sand the wall or wash it with diluted acid (rinsing well after completing the operation);
- In the presence of dust or moss wash with water at high pressure;
- After washing the base, ensure there is no film of water when applying the adhesive, given its lack of absorbency;
- Note the temperature of the base as reinforced concrete holds heat and could overheat the adhesive in summer (or freeze it in winter);
- In the case of retaining walls there must be suitable waterproofing on the side facing towards the soil, otherwise water infiltrations could cause detachment or the appearance of chronic efflorescence. To prevent this issue it is advisable to make holes for water drainage (and include the wall covering), or put up false asbestos cement walls to separate the stone from the wall. There is no waterproofing solution on the visible side (facing away from the soil) that will provide long-lasting protection (see section 3).
- **A double coat must always be applied to reinforced concrete otherwise detachment issues will eventually arise.**
- **Prefabricated reinforced concrete structure:** it should be considered that prefabricated structures undergo considerable movement. External cladding reduces this phenomenon significantly by stabilising temperature and internal humidity. Any sort of covering on it is no longer affected by structural movement, given that the cladding insulation panel is an excellent shock absorber due to its elasticity. Always fit the covering in accordance with structural joints, reproducing them on the surface.

6.4 IRON

Apply a layer of tar to iron bases followed by a 2-mm galvanised electro-welded metal mesh (5x5 cm mesh) secured to the loadbearing structure with screws/staples at a maximum distance of 20 cm from each other, turning the mesh back on itself at corners and overlapping joints by at least 10 cm. Keep the mesh a few millimetres away from the base so that the next application of Geocoll® can surround the metal wires completely. Install the wall covering once completely dry.

6.5 HEAT-INSULATED PLASTER

The heat-insulated plasters on the market have been designed to be breathable and resist the passage of heat but their mechanical strength is only sufficient to support light wall

coverings. murogeopietra cannot be applied directly as it weighs considerably more than a standard finish.

To eliminate any risks it is advisable to remove processing dust with water, then attach 160 g/m² of fibreglass mesh embedded in a double layer of Geocoll®, overlapping joints by at least 10 cm. Secure the arrangement using insulation wall plugs of a suitable type, shape and length for the base at a maximum distance of 50 cm from each other (i.e. 4 pieces/m² minimum), and cover the head plate with Geocoll® to prevent water infiltrations.

6.6 READY-MIXED PLASTERS

There are several types of ready-mixed plasters with different mechanical characteristics depending on **the composition and type of processing**. Each case should be assessed carefully by the installer by testing resistance (cutting with a small metal object) and consulting the product information leaflet. In general plasters which are lime-based only (usually used internally) must be reinforced using **mechanical anchoring with Georete** (see section 5).

Lime and cement-based plasters could provide good resistance, provided they are only worked with a plastic or wooden straight edge and trowel. However, if a plane (scratch float) is used the wall must be washed and, when the damp film has disappeared, strengthen the surface resistance with a layer of Geocoll® (with a fairly soft paste and possibly inserting 160 g/m² of fibreglass mesh). Install the wall covering once completely dry. **If there are any doubts over base resistance it is advisable to carry out a pull-off test.**

If the Murogeopietra is to be fitted to walls with no guttering or which are very exposed to bad weather the use of waterproof plaster is recommended.

6.7 VARIOUS PAINTS OR FILM FINISHES

Take care in the presence of paints as there is no treatment or pitting technique that can ensure the integrity of the wall covering. Two reliable procedures include:

1. **The complete removal of the paint down to the stable base.** Remove the surface layer completely by sanding or using a stripping machine until a stable base is revealed, wash with water to remove dust and coat the surface with Geocoll®. Install the wall covering only once completely dry.
2. **Installation by mechanically anchoring to the base.** For mechanical anchoring attach Georete fibreglass mesh embedded in a double application of Geocoll®. Once dry, secure the arrangement using wall plugs of a suitable type, length and shape for the base at a maximum distance of 50 cm from each other. It is advisable to turn the mesh back over on itself at the corners and overlap joints by at least 10 cm. Ensure the next layer of adhesive also covers the heads of all the plugs. Install the wall covering once completely dry.

On the inside it may be quicker to attach a false plasterboard wall mechanically to the base (see instructions in section 6.13). Outside it is advisable to **anchor mechanically with Georete** (see section 5).

6.8 BASES WITH RISING DAMP

Geopietra® is highly breathable but is not a moisture-removing material, however by using suitable systems and materials it can still be used on areas with rising damp. This depends on the extent of the damage, which should be assessed by the installer:

- **Extensive softening on the base with plaster clearly coming off:** remove down to the base, restore with reputable anti-damp plaster, put up a false wall at least 4 cm away from the supporting wall, with posts and slabs in asbestos cement. Fit the stone to this structure after a double application of Geocoll® reinforced with Georete fibreglass mesh. On external skirting, the covering can be finished off with an upper section or other material depending on preference. It is very important to install vents at the top and bottom to enable adequate air circulation and keep the base dry. (Fig. 6.8).
- **Signs of plaster softening:** remove any layer that could create a barrier to breathability and remove as much of the plaster around ruined parts as possible. Restore with moisture-removing plaster, which can also be used as an adhesive and grout for the stone itself.

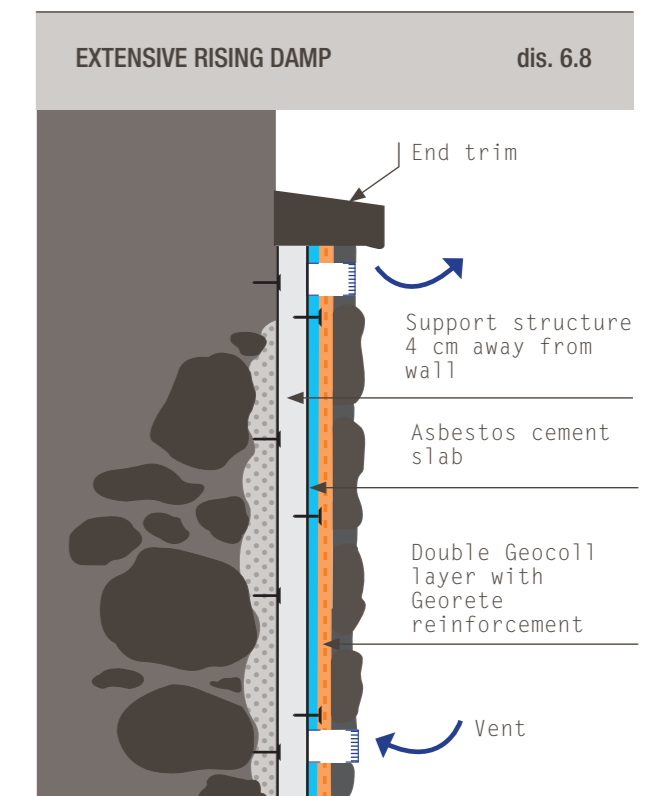

- **Small signs of paint flaking off:** remove any layer of material that could create a barrier to breathability (e.g. paints or treatments), glue with **Geocoll®** and grout with **GeoBi**.

6.9 BASE TREATMENTS

Included among hazardous bases comparable to paints are all surface treatments and deep sealants that have not penetrated properly (with the formation of a surface film).

The use of these products makes testing necessary before proceeding with the installation. Apply the adhesive and carry out a pull-off test once dry. Adhesion is only guaranteed if the base (e.g. plaster) secured to the adhesive comes off along with the stone.

6.10 TAR OVERLAP

No adhesive can guarantee secure installation in the case of tar overlaps. It is advisable to use **Georete** fibreglass mesh secured over two thirds of the structure and a third overlapping the sheath. Proceed with mechanical anchoring as outlined in section 5 and apply the **Geopietra®** covering once completely dry. Any loose sheath will be supported and held by the reinforcement over time.

6.11 GYPSUM PLASTER FOR INDOOR

The characteristic of this base is a high level of absorbency. To avoid problems a waterproof bonding treatment must be carried out using a **deep bond coat primer** at least 24 hours before installation.

Avoid surface primers or similar which can form a film causing the wall covering to come off. To test the effectiveness of the primer, glue some stone and once dry perform the pull-off test. Adhesion is only guaranteed if the base comes off along with the stone.

A good alternative to the primer consists of etching into the base, soaking it well with water and installing the covering, which must never be carried out in the presence of a film of water. To avoid any treatment it is possible to use one of the many adhesives on the market especially for gypsum and plasterboard bases.

6.12 PLASTERBOARD

A partition or false wall consisting of a steel or wood loadbearing structure and sheets of plasterboard can support the weight of the Murogeopietra, but it may be not be able to withstand the stress created by the covering when drying.

The Geopietra covering shrinks when the adhesive and finishing materials are drying, which normal brickwork bases can tolerate, however plasterboard may not be able to withstand the stress and cracks could form on the covering. It is difficult to stipulate a rule for all situations, as the behaviour parameters vary depending on

surrounding temperature, amount of water used to grout joints, type of filler used, wall dimensions and how the steel structure has been constructed, etc.

The most significant issues transpire in the following cases:

- Wall dimensions over 5 metres in length.
- Winter installations when drying times are longer.
- Grout with too much water.
- With full and overgrout joints.

A possible solution is to even out the base with a double application of Geocoll and Georete reinforcement (it is advisable to reduce the absorption strength in the case of normal sheeting - see section 6.11). When the wall is more than 5 metres long, split it up using a false column or something else which acts as a joint. Shorten drying times by heating the area where the work is implemented (15-20 °C).

In the case of plasterboard walls that have already been painted, it is possible and practical to secure another sheet to the underlying structure, in order to create a secure base.

Using a magnet identify the position of the columns and screw on damp-proof sheets, staggering the joints with respect to the previous joints and obtaining a perfect surface for installing the Geopietra, without even grouting the new joints.

Alternatively proceed with a mechanical anchoring technique (see section 5).

6.13 MINERAL WOOD FIBRE PANELS

Material used as disposable formwork, where fixing to the structure involves the concrete itself and the base does not have fixed dimensional stability. The absorption of water could lead to considerable expansion, resulting in complete detachment from the base after occurring several times.

Proceed by checking the anchoring of the panels to the base and fit mechanical plugs if necessary.

Make the surface uniform with a double application of **Geocoll®** adhesive and insert **Georete** fibreglass mesh, folding it back on itself at the corners and overlapping joints by at least 10 cm.

6.14 WOOD FIBRE BLOCKS

With wood fibre blocks implement a double application of **Geocoll®** adhesive, inserting 160 g/m² fibreglass mesh and folding it back on itself at the corners and overlapping joints by at least 10 cm.

6.15 LOOSE BASES

With particularly loose bases or bases with significant movement, a false wall with a galvanised steel structure can be erected (or wood to avoid electromagnetic fields), covered in plasterboard (internal) or asbestos cement (external). (See specific installation procedures).

6.16 WATER AND STEAM: showers, bathtubs, swimming pool edges, saunas and Turkish baths

One of murogeopietra's main features is good permeability which enables walls to breathe and makes homes comfortable, therefore the material has good surface absorbency characteristics. It is not an issue for it to be in contact with water but, as with natural stone, it is subjected to the harshness of chlorine or salts in swimming pools, and chemical products and detergents used for cleaning.

A) In showers, bathtubs, swimming pools and similar places, where hygiene is of the utmost importance and the impermeability of coverings is crucial, Geopietra® manufactured stone veneer is not very practical and therefore not recommended. If installation is desired regardless proceed as follows:

1. Waterproof the base using a suitable cement-based product (osmotic cement), reinforced with 160 g/m² of fibreglass mesh.
2. Glue the stone with special adhesive for use under water (adhesive for swimming pools) and then grout.
3. Wait until the walls are completely dry (6-8 weeks in a heated environment) and apply a protective glaze treatment. The treatment should create a surface film that does not permit absorption. It is advisable to use models with surfaces that do not have too many indentations, avoiding dry-stack installation-cleaning could be problematic and impractical, resulting in the accumulation of dirt and germs in the stone recesses.

B) In areas where murogeopietra is installed in the vicinity of swimming pools and is only occasionally affected by sprays of salt water or chlorine, wait until the walls are completely dry (6-8 weeks in a heated environment) and apply a water-repellent treatment. Opt for a water-based protective treatment, such as a siloxane treatment, which does not affect the breathability of the stone (open pore) or change its appearance.

C) In sauna rooms or Turkish baths Geopietra® manufactured stone veneer is only dampened by steam, therefore it is not subjected to harsh conditions due to chemicals. The stone acts as a steam drum by regulating the steam, therefore it is advisable not to proceed with any type of treatment, enabling the material to breath as much as possible. Apply the wall covering following steps 1 and 2 in section A (showers, bathtubs and swimming pools) and clean regularly (see section 15). To reduce any absorption an open-pore siloxane treatment can still be applied once the wall is completely dry.

6.17 FIREPLACES AND STOVE AREAS

Covering fireplaces, chimney breasts and stove areas should not pose any problems, the only precaution is to ascertain whether or not the surface temperature exceeds 180°C, which is the maximum limit that can be tolerated by the adhesive and mortar, therefore beware of any thermal expansion in the loadbearing structure. The installation of **murogeopietra** within barbecue areas is not recommended.

6.18 INSTALLATION ON WATERPROOFED WALLS

There may be several reasons as to why a wall has been waterproofed, and in this situation mechanical anchoring by making holes directly in the waterproofing layer cannot be implemented to support a covering.

There are waterproofing materials such as bentonite cements, which the adhesive grips without any issues. Obviously the base waterproofing must be guaranteed by the supplier and installer of the waterproofing material, as it is this which has to withstand stress due to the weight and thermal expansion of the covering.

It is difficult to find a solution for other waterproofing materials, such as bitumen sheets, as no adhesive can maintain suitable grip over time. In the case of small waterproofed surfaces with a maximum height of 40-50 cm on the bottom of walls with a secure base, they can be overlapped with fibreglass Georete, covering the equivalent length of the wall at least, to allow for the mechanical fasteners secured to the structure. Set this in a double application of Geocoll and wait till it is completely dry before fitting the covering (see section 5).



In the pictures

Installation on ventilated wall you can note the split created by the strong tensions due to a wrong substructure made of wooden posts to which cement sheets were fixed.

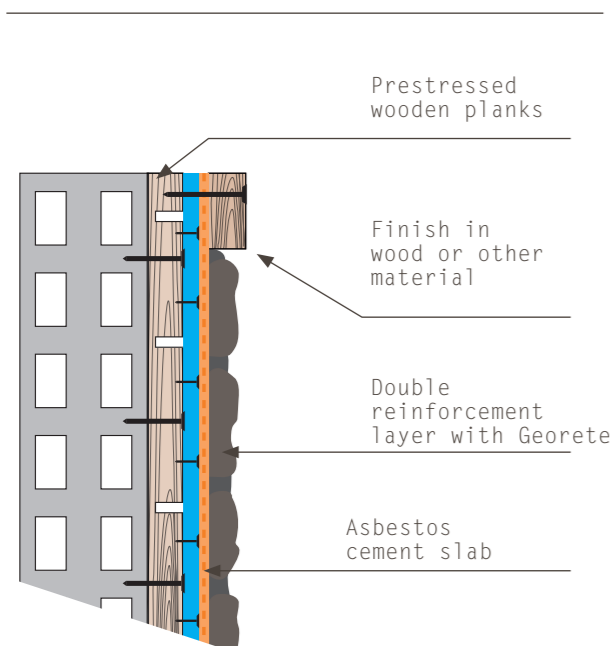

6.19 EXTERNAL VENTILATED WALLS (ASBESTOS CEMENT SHEETS)

A steel or aluminium criss-cross structure secured to the base with plugs is normally used to ensure free movement in all directions. Asbestos cement sheets are secured to the structure using self-drilling screws positioned 20 cm apart, which are guaranteed by the supplier to support a covering of approximately 70 kg/m².

Feasible surfaces must have maximum dimensions, dictated by the sheet supplier, that consider movement due to the thermal expansion of the materials used. As a precaution it is advisable to apply a double layer of **Geocoll** on these surfaces to further mitigate movement and prevent accidental breakage points that are difficult to detect in the design stage. Ventilation holes are necessary at the top and bottom of the wall and should also be observed when installing the **Geopietra**.

Issues transpired on site for the following reasons:

- Asbestos cement sheets secured to simple vertical or horizontal columns being subjected to movements in the underlying structure.
- The aforementioned problem is exacerbated with the use of wood strips in the structure, which move significantly with changes in temperature (see photo). If these have to be used, it is advisable to counteract this by making cuts in the wood strips perpendicular to the grain at a distance of 1 metre using a saw (see diagram).

6.20 WOOD AND MIXED STRUCTURES

Wood typically moves continually and manufactured stone veneer must be installed on a perfectly stable base or a base with expansion characteristics similar to the manufactured stone veneer, making compatibility difficult. The recommended solution consists of putting the **Murogeopietra** on a separate surface to the wooden loadbearing surface, such that it is not subjected to the movements.

1. False wall in asbestos cement on a criss-cross structure.
2. External thermal insulation.

The first is described in section 6.19 and can be used in special cases with bases that are very loose or similar.

The second is more highly-recommended for obvious thermal reasons, and especially because it acts as an excellent shock absorber for any movements in the underlying structure, with the exception of expansion joints, which must always be on the surface. Gluing insulation onto wood can create adhesion issues and many manufacturers recommend secure plugging

techniques. The procedure used in our guaranteed solution is outlined below; always consult the insulation manufacturer.

A loadbearing wooden structure must have a protective wooden structure on the whole outer surface (diagonal covering: 3-S, OSB panels or similar) to enable adhesive to be applied to the entire surface, in addition to suitable mechanical anchoring. In principle, the entire surface of the insulation should be covered with a suitable adhesive and secured immediately with 2 wall plugs. The **GEOPIETRA** covering must then be secured mechanically using self-threading screws in a 40x40 cm wall plug pattern, without requiring holes to be drilled beforehand using an 8-mm drill.

At joints between massive brickwork (e.g. cellar) and wood there are structural expansion joints that must be observed in the insulation (sealing tape, skirting profile or other solutions). Alternatively, anti-damp plasterboard sheets can be screwed to the loadbearing structure onto which the insulation can be glued.

6.20.1 WOOD PANELS TYPE OSB

The OSB panels type, fitted on an appropriate underlying structure, such as a lattice structure of small beams, are not subjected to movements and a covering can be fitted after preparing the panels as follows: position a micro-perforated steam-permeable membrane on the wooden structure and then a 2-mm galvanised wire electro-welded metal mesh (5x5 cm mesh) secured to the loadbearing structure with screws/staples at a maximum distance of 20 cm from each other, turning the mesh back on itself at the corners and overlapping joints by at least 10 cm. Keep the mesh a few millimetres away from the base so that the next layer of **Geocoll**® can surround the metal wires completely. Install the **murogeopietra** once completely dry.

6.20.2 WOODEN HOUSES

It should be considered that prefabricated structures undergo considerable movement in general. External cladding reduces this phenomenon significantly by stabilising temperature and internal humidity. Any sort of covering on it is no longer affected by structural movement, given that the cladding insulation panel is an excellent shock absorber with its elasticity. Structural expansion joints must be observed when installing the covering.



The photograph shows the crack caused by a lack of waterproofing on the wood base. The penetrating water, or even just the dampness, has caused the materials to expand and their movement has split the stone at the corners.

INCORRECT INSTALLATION ON WOOD

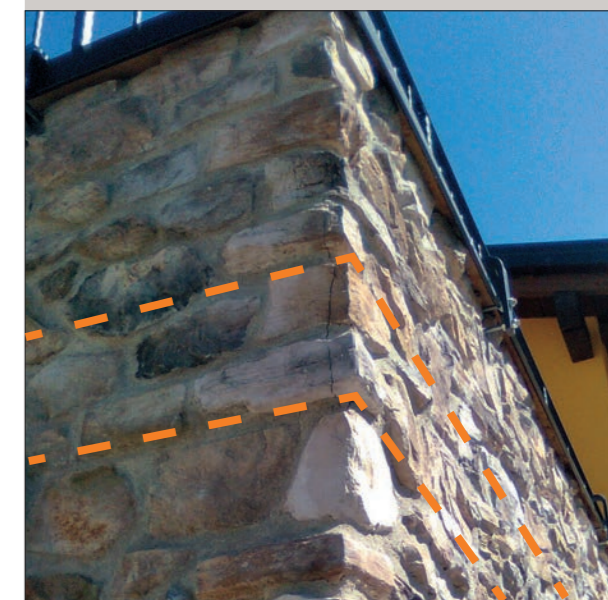

The photograph shows cracks at the corners at the level of the loadbearing slab, where an OSB panel was screwed **directly onto the horizontal laminated beam**. The beam expanded and triggered sufficient forces to break the end section of the glued stone.

COVERING IRON AND WOODEN PILLARS

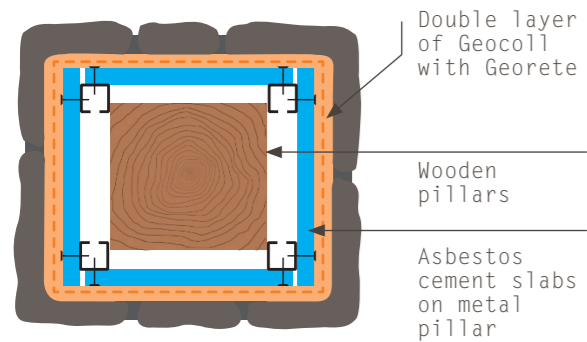

To cover iron and wooden pillars and prevent the expansion of materials cracking the covering, it is advisable to box the structure in with plasterboard and asbestos cement slabs, leaving the arrangement slightly detached. If anti-damp plasterboard sheets are used also apply EPS insulation. In both cases it will be necessary to wrap **Georete** fibreglass mesh embedded in a double layer of **Geocoll** adhesive around the structure.

It is advisable to bring the pillars to the minimum external dimensions of 25x25 cm before covering them with the **Geopietra** manufactured stone veneer.



6.21 | INSTALLATION ON EXTERNAL THERMAL INSULATION

Recent legislation on energy savings stipulate efficiency requirements for buildings. As a result, the use of thermal insulation is becoming increasingly widespread in homes, and therefore the need to implement an expert installation on such surfaces.

Geopietra® can boast extensive knowledge on the subject, and after many years of development and rigorous laboratory testing can offer a **guaranteed integrated system for installing Murogeopietra on external thermal insulation**.

MUROGEOPIETRA on external thermal insulation requires special care during design and implementation, both in terms of technical and aesthetic factors.

When sizing window frames and sills, rails and door frames, it is important to remember that a surface covered with Geopietra manufactured stone veneer will protrude approximately 6-7 cm from the insulation, whereas the TERRAKOTTA covering will protrude approximately 2-3 cm (thickness varies depending on the model). Page 58 illustrates useful strategies for installation on external thermal insulation around windows.

GUARANTEED PROCEDURE

Specific strategies for the guaranteed procedure:

The materials and procedures used in external thermal insulation systems must comply with ETAG 004 certification.

Manufacturers of external thermal insulation must guarantee a capacity of 70 kg/m².

The area of adhesion on the insulation panel on the structure must exceed 60% of the area of the panel itself.

On the layer of reinforced plaster created on the insulation panel there **must have been no treatment using primers or finishes** before installing the Murogeopietra.

The procedure must be carried out by qualified personnel in accordance with standard work practices and technical standards.

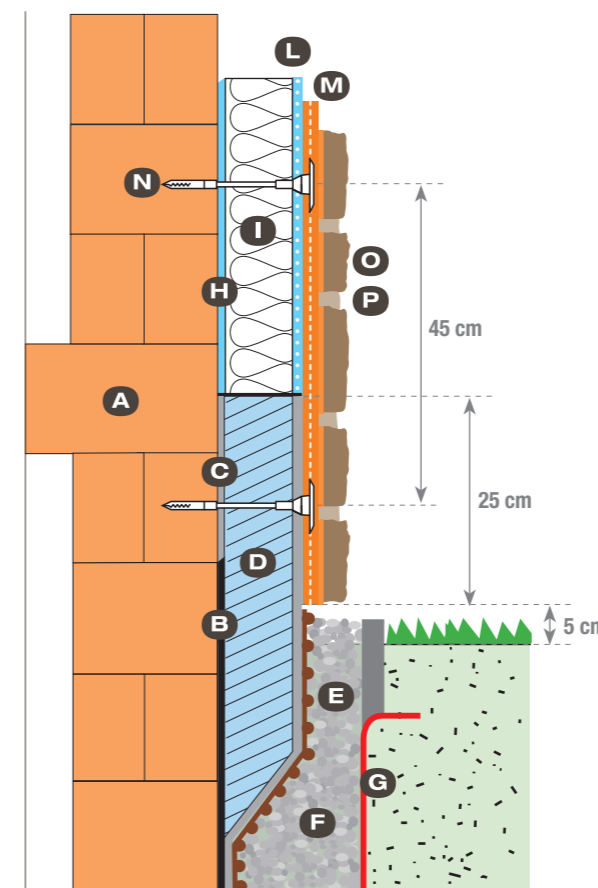

GENERAL STRATIGRAPHY

- A. Bearing wall
- B. Foundations waterproofing
- C. Waterproofing adhesive and skim coat
- D. Insulating panel for external skirting
- E. Dimpled membrane
- F. Drainage material
- G. Nonwoven fabric (TNT).
- H. Adhesive and skim coat
- I. Insulation panel
- L. Reinforcing mesh embedded in the glue layer
- M. GEORETE supporting mesh embedded in GEOCOLL glue layer
- N. GEOPIETRA TOPFIX screw-on system (suitable plugs for mechanical anchoring)
- O. GEOPIETRA veneer stone installed with GEOCOLL glue
- P. GEOBI two- component grouting mortar

MECHANICAL FIXING

The insulation system must be fixed mechanically using special studs for thermal insulation systems, featuring the GEOPIETRA TOP FIX screw-on system. The studs should be of a suitable length, according to the insulation thickness, and should have at least 25mm expansion clearance inside the masonry, depending on the backing.

The anchoring studs must pass through the consolidated layer of reinforcement plaster and the GEORETE fibreglass mesh substrate embedded in the still fresh layer of GEOCOLL® adhesive.

The insulation system should be fixed mechanically possibly by the fitter of the GEOPIETRA stone veneer.

Anchoring holes for fixing the insulation system mechanical fixing are drilled in the properly set reinforced smoothing layer of the ETAG 004-certified thermal insulation.

The studs are positioned according to a 40x40cm raster layout, corresponding to 6.37 studs per square metre. In the perimeter areas (200cm from the building corner), there must be 12.49 studs per square metre. This data is indicative and must be verified according to the 1991-1 standard.

The murogeopietra procedure on EPS meets criteria for non-propagation of a flame front beyond the next floor level, and is authorised to cover R+2 category public buildings / CSTB - LEPIR II. (see page 10)



DRILLING SCHEME

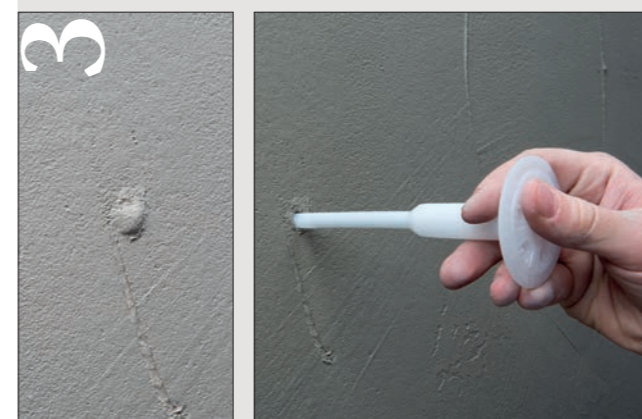
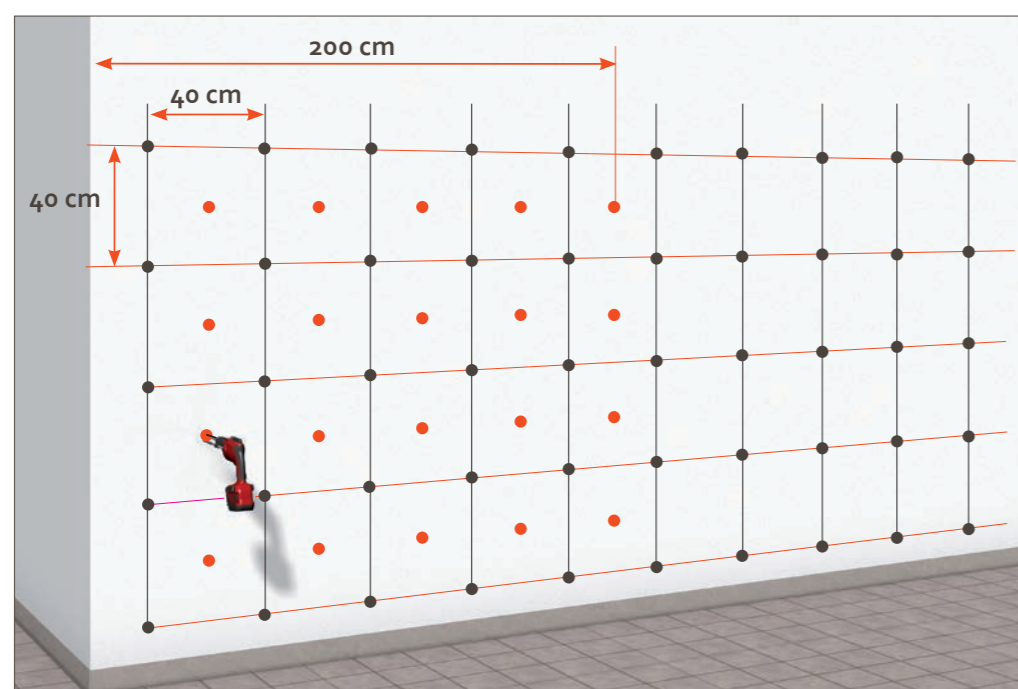

1. DRILLING AND MILLING

Use an 8mm bit drill to make holes of at least 10mm depth in addition to the anchoring depth. Clean the holes thoroughly.

Countersink the hole to obtain a 16-18mm diameter flare to allow for flush screwing of the stud plate.

2. FIRST MASONRY SMOOTHING USING GEOCOLL

Use a smooth knife to apply a 2mm layer of soft GEOCOLL adhesive to the backing.

3. MARKING THE HOLES

Although the milled holes are covered with adhesive, they remain visible because they form a small bubble that can be highlighted by perforating it with a tip prior to the application of the GEORETE mesh substrate.

4. LAYING THE GEORETE MESH SUBSTRATE

Bury the GEORETE large fibreglass mesh by overlapping the joints by at least 10cm.



TOPFix



TOP FIX Screw wall plug with cap
Thermal conductivity: λ 10 dry < 0,002 W/mK
SHANK: Ø 8 mm~ / PLATE: Ø 60 mm

CATEGORIES: A Concrete / B Solid brick / C Brick
D Light vibrated concrete / E Foam concrete

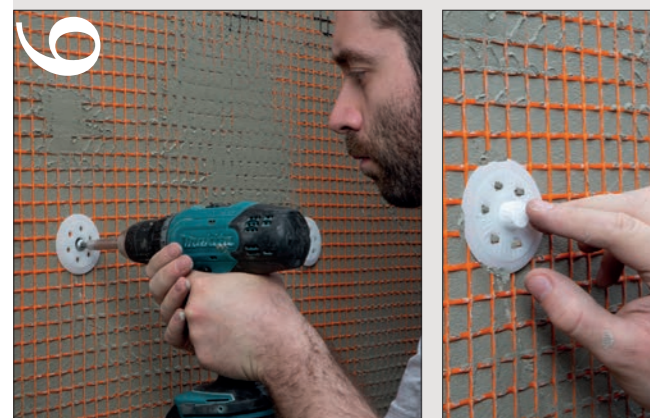

5. INSERTING GEOPIETRA TOP FIX STUDS

Immediately insert the Geopietra Top Mix studs by hand into the pre-drilled holes.

6. SCREWING IN AND SEALING THE STUDS

Use a screwdriver to screw in flush with the surface top. Any studs that do not adhere should be removed or replaced. Insert the closing plugs provided with the Geopietra Top Fix studs.



7. SURFACE FINISH

Apply an even layer of Geocoll adhesive to cover the mesh and stud heads completely.

Especially when the cladding is installed "dry", i.e. the joints are not filled with mortar, make sure the stud heads are fully buried in the smoothing adhesive and add extra GEOCOLL, if necessary.

When the adhesive has properly set, the wall is ready for the installation of the stone veneer.

8. THE MUROGEOPIETRA INSTALLATION

Install murogeopietras only after completion of the installation of the laying insulation system to prevent dirtying the cladding. GEOPIETRA stone veneer must be laid not before 5-7 days from the date of installation of the insulation panels. The structural expansion joints that are already sealed should be left free.

Care should be taken to properly install murogeopietra, in accordance with the manufacturer's technical guidelines set out in this installation manual.



murogeopietra: installation on external thermal insulation system.



6.22 INSTALLATION ON EXISTING PLATED THERMAL INSULATION

In the case of existing insulation the only possible assessment to carry out regards the integrity of the surface layer, whereby adhesion to the base will be unknown. As a result the following procedure only concerns dealing with the visible part and increasing mechanical anchoring. Clean the visible layer of plaster thoroughly, removing worn or unstable parts and restoring with special insulation adhesive or Geocoll® adhesive if necessary.

Insert the Georete support mesh in a double application of Geocoll®. Secure the assembly with plugs suited to thermal

insulation forming a strong secure 35x35 cm grid.

When choosing **wall plugs** it is important to know the base material used in order to choose the most suitable plugs and have the maximum grip. The **murogeopietra** can be installed once completely dry.

If the thermal insulation is clearly fragile with surface cracks and considerable water infiltrations the only solution is total replacement, in which case we would recommend the **cladding guaranteed procedure**.

GEOColl®



On the Geopietra channel
watch the video: "Colour GeoColl"

With a dry-stacking installation of dark models, the use of light-coloured adhesive will be obvious between joints, giving an uneven effect of depth. To avoid this, Geopietra has created a new powder dye to be mixed in measured amounts into a bag of GeoColl.

Available in 2 colours BLACK and BROWN. BLACK, suitable for any situation except for Bianco Marmo and Bianco Terra. BROWN, ideal for Leone and for all shades of Brown.

Working with a coloured adhesive makes it easier to cover cracks and profiles in the stone during installation.

The specific colour powder for the adhesive GeoColl, plays an important role when installing **murogeopietra plus**. The coloured GeoColl makes the installation faster, avoids the final touch-up and achieves a natural result.

COLOUR for dry-stacking installations

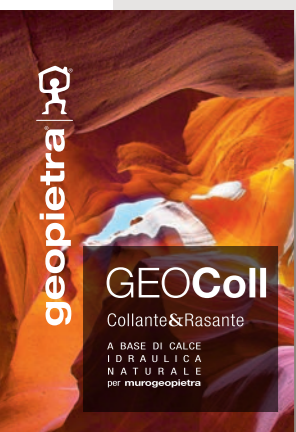

7 | GEOCOLL® ADHESIVE and SKIM COAT BASED on NATURAL HYDRAULIC LIME

Despite the fact that there are good quality adhesives on the market, Geopietra® manufactured stone veneer requires very special characteristics that cannot be fully met with any of those available, most of which have been developed for use with ceramics (EN12004). However, Geocoll® has been produced in accordance with EN998 and has been specially optimised to improve the performance and duration of installations on any base or external thermal insulation.

Geocoll® contains natural hydraulic lime, giving the product features such as improved flow characteristics, zero vertical slump, breathability and good mechanical properties. It is practical to use and facilitates the work of installers by dealing with issues that have transpired over the years when carrying out installations on site. Along with Georete fibreglass mesh, Geocoll® is also the ideal product for applying reinforcement solutions to unstable bases (see section 5) or support reinforcement for external thermal insulation.

PREPARATION

Mix a 25-kg bag of Geocoll® with 7.0 L (adhesive) or 7.5 L (skim coat) of clean water using a mechanical stirrer till a smooth paste with no lumps is obtained. Let it stand for 10 minutes then mix again briefly.

The consistency of the paste can be adjusted by adding small amounts of water. The adhesive is applied using a 'wet-on-wet' technique i.e. Geocoll® is spread over the back of the stone with a trowel (without teeth) and a thin layer must be applied to the installation base. The stone should then be pressed onto the wall using slight sideways movements from left to right until excess adhesive can no longer be pressed out (suction effect). If the stone slips downwards use Geocoll® with a thicker consistency. Position the stone accurately and uniformly, remembering that after approximately 15 minutes the stone can no longer be moved or removed. Highly absorbent bases can be dampened beforehand, ensuring there is no film of water when gluing the stone.

NOTE

Operating temperature +5°C to +35°C ambient. **Do not install with base temperatures lower than +5°C or greater than +25°C.** With very hot ambient temperatures check that the wall does not exceed critical values for the adhesive (water evaporating too quickly in the adhesive blocks the chemical gripping action). If this is the case cool the base by wetting the surface with plenty water, and the back of the stone itself if necessary. Geopietra® should then be installed when there is no film of water. Protect from rain, do not apply to frozen or thawing bases, suspend installation with temperatures close to zero or if there is a risk of frost in the next 24 hours. If there is the possibility that temperatures may fall significantly at night cover the completed work with glass wool. Do not use hardened material. Do not add water to restore workability. Do not add other materials which are not included in the product information leaflet. Comply with any structural joints.

8 | WET-ON-WET INSTALLATION with DOUBLE APPLICATION (suction effect)



IMPORTANT

Simply laying the item on the wall, which is typical with ceramics, will not ensure correct grip (even with very soft adhesive) and will lead to the product detaching over time.

1. USE A TROWEL TO SPREAD AN EVEN LAYER OF GEOCOLL® ON THE BACK OF THE STONE.

Never use a trowel with teeth to spread adhesive on the base (as is standard with tiles). Spread Geocoll® over the entire back of the stone - adhesive only dotted here and there will concentrate load in small spaces and could create cracks or detachment due to thermal expansion. Take special care with panel models.

2. ALSO APPLY A THIN LAYER OF GEOCOLL® TO THE WALL.

Using the edge of the trowel spread a thin layer of adhesive on the wall where the stone will be positioned, in order to implement the wet-on-wet technique.

3. POSITION THE STONE BY EXERTING PRESSURE AND SMALL MOVEMENTS.

Move the piece until excess adhesive is pressed out, ensuring perfect adhesion.

Vertical movements (up and down) for corner pieces as shown in photo 3.

Sideways movements (left/right) for flat pieces as shown in photo 5.

THE MOVEMENTS SHOWN IN PHOTOS 3 AND 5 ENSURE THE ADHESIVE STICKS TO THE BASE WITH A SUCTION EFFECT.

Avoid striking the stone with the fist or rubber mallets.

9 | INSTALLATION TECHNIQUE

Depending on the case, THE STONE MODELS can be laid in 4 different versions:

INSTALLATION WITH JOINTS
 INSTALLATION WITH JOINTS + GeoFit BIG and SASSO
 DRY-STACK INSTALLATION
 DRY-STACK INSTALLATION **murogeopietra plus**

1. MIX THE MATERIAL. DO NOT USE STONE FROM A SINGLE BOX OR PALLET.

Before commencing arrange a small amount of stone near the work area from different boxes and pallets to have a good choice handy. During installation try to achieve balance in terms of shape, dimensions, colour, thickness and grain pattern.

2. MARKING THE WALLS.

Using a pencil or plotting tool mark horizontal lines 20-30 cm apart on the wall to be covered, as a reference point for the next course to be completed.

3/4/5. STARTING AT CORNERS.

Fit corner pieces first, starting from the bottom with the largest pieces and proceeding upwards with increasingly smaller dimensions. As the corners have a long and short side, they must be installed in an alternating pattern with respect to the edge, making the design look more authentic by following the classic joint design of stone constructions. **Always use the wet-on-wet technique.** Proceed from the bottom positioning the largest stones; this is very important for making the wall look authentic and keeping courses horizontal (see section 9.1). Then insert GeoFit chips of a suitable shape and matching colour into the empty spaces. (see pages 16-17). In grouted versions maintain a distance of approximately 1.5-2.5 cm between the stones. Alternate small/large, tall/short, dark/light stones as much as possible to create natural-looking joints.

6/7/8. CUTTING AND PREPARING.

To obtain the best laying result, the stones can be cut or shaped using a hammer, wide mouth pliers or trowel edge, if necessary. Straight cuts can be made using a diamond saw. Cut profiles should be positioned so they are not visible (facing downwards when the stone is below eye level and upwards when above eye level). Use thin stone to conceal any cuts better. **Any stone broken during transportation can also be used for this purpose.**

9. OFFSET THICKNESS IRREGULARITY WITH GEOCOLL®

Geocoll® has also been specially designed for use to compensate for any irregularities with pieces created manually. It is particularly useful on corner pieces to even out overhangs and obtain a straight edge.



On the Geopietra channel you can watch the video: "Guide to the laying MUROGEOPIETRA" which has tips for fitting the product to professional standards.



During installation avoid getting the stone dirty with Geocoll® by always working with clean hands. Any adhesive marks should be removed immediately using clean water and a sponge. When cleaning the stone once installed only treat the area concerned to avoid making unnecessary marks.

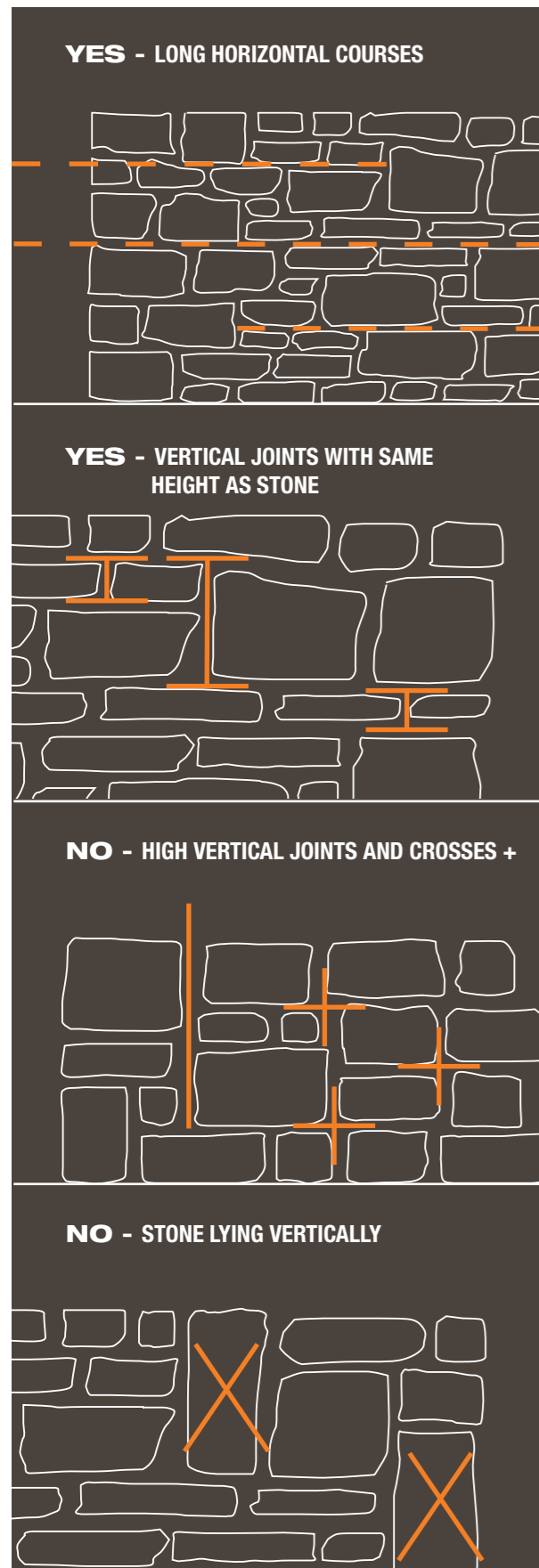

9.1 LONG HORIZONTAL COURSES

Present day use of stone as an aesthetic rather than a loadbearing feature still requires knowledge and respect for the construction logic that underlay the use of this material.

HORIZONTAL JOINTS are very important for making the wall structure look authentic and can be of varying lengths depending on taste and model. VERTICAL JOINTS must never be interrupted or continue above the height of an individual stone.

Each stone must be staggered with respect to the stone underneath in order to 'connect' them and give the wall coherence (see side diagrams).

9.2 PANEL MODELS

The P12 Monte Panel, P16 Scaglia and P36 Rigo models are constituted by panels. As with the other series they have been produced manually and do not have regular profiles as ceramic products do, therefore they may have slight irregularities at the edges which can be corrected at the time of installation.

The same installation rules for other models still apply, but the procedure is quicker due to the configuration of the pieces, which enables a layered installation with one positioned on the other, staggering the vertical joints.

Mark a horizontal line and control the course pattern with a straight edge and level.

Prepare the aforementioned corrections on pieces as required using a diamond wheel. **Any pieces broken when being transported can be used at the ends of walls or for butting along with the others.** (Positioning on the wall is very similar to that of standard ceramic tiles, but the characteristics of the material and its configuration require a completely different adhesive and base to be used.

Almost all issues that have transpired with Geopietra® products resulting from incorrect installation have occurred with these two panel models, due to their presumed ease of use.

To avoid any problems, after assessing and preparing the base install as follows:

Spread **Geocoll®** over the entire base of the panel as with all other models, and not in a random dotted pattern.

Installation must always be implemented with a double wet-on-wet application, spreading the Geocoll® on both surfaces and sticking the stone to the base using pressure and small sideways movements to ensure perfect adhesion.

Lack of adhesive makes the work flimsy and thermal expansion and knocks will almost inevitably cause breakage.

Even an application of several square metres on the installation

base, with a layer of a few mm of Geocoll® and the stone fitted immediately, is the wrong procedure. Pieces installed in the first few minutes will adhere perfectly, but as time passes the coat will undergo initial shrinkage, making the base fragile and at risk, with the possibility/certainty that the stone subsequently installed will detach (see section 10 Breakage and Detachment).

9.3 EXPANSION JOINTS

Leave joints free, putting the stone in the immediate vicinity. If joints are to be disguised glue the stone onto one of the supports with the larger surface, leaving the rest free to move. By doing so the joint will follow the shape of the stone and become invisible when grouting is completed. If the grout cracks over time it can be restored by simply replacing the grout.

9.4 INSTALLATION TIMES

Installation times vary depending on the model used. The longest times are required for the Moderno, Toce and Blumone models, whereby an expert installer would take one day to install approximately 6-8 m² using a dry-stacking technique. Models with reasonably regular shapes such as Londra, Bergamo, Vallese, Castello Inglese can be installed at a rate of 10-15 m² per day. Models with unspecified installation times, such as Lavone, Botticino and Turano, make it possible to achieve 15-20 m² per day. The Scaglia and Monte Panel models (consisting of modules with heights of 10 cm and 12.5 cm respectively and variable length, designed for dry-stacking installation) have been specially designed to speed up installation times (20-25 m²/day), but the 'natural' effect obtained with other models is compromised to some extent. Furthermore, their presumed easy installation often means essential rules are ignored, resulting in most of the issues with detachment that have transpired to date.

All installation times indicated are based on the work being carried out by industry experts.

On the Geopietra channel you can watch the video: "Masking Joints" and "Dry-stack Installation".

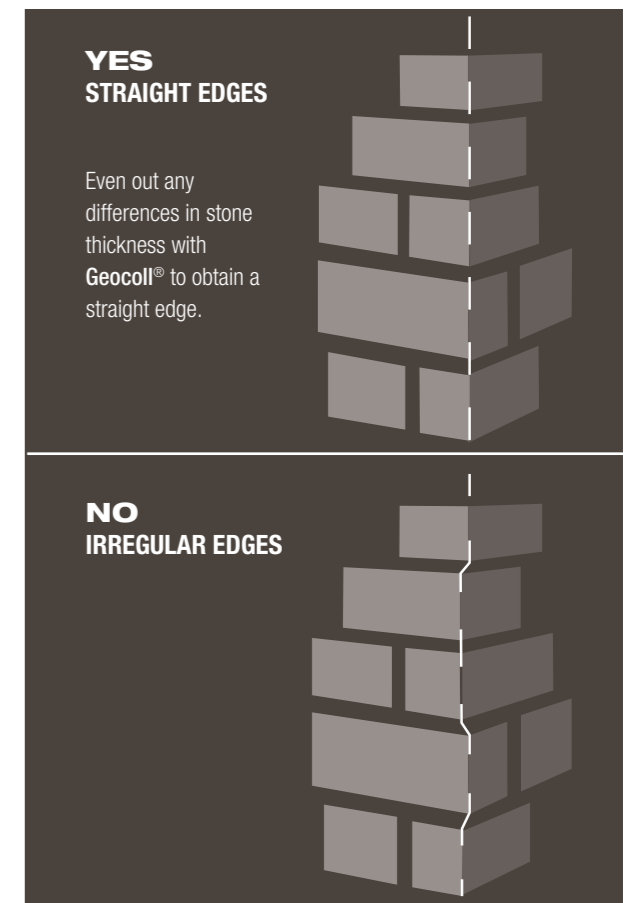

CONCEALING EXPANSION JOINTS

9.3

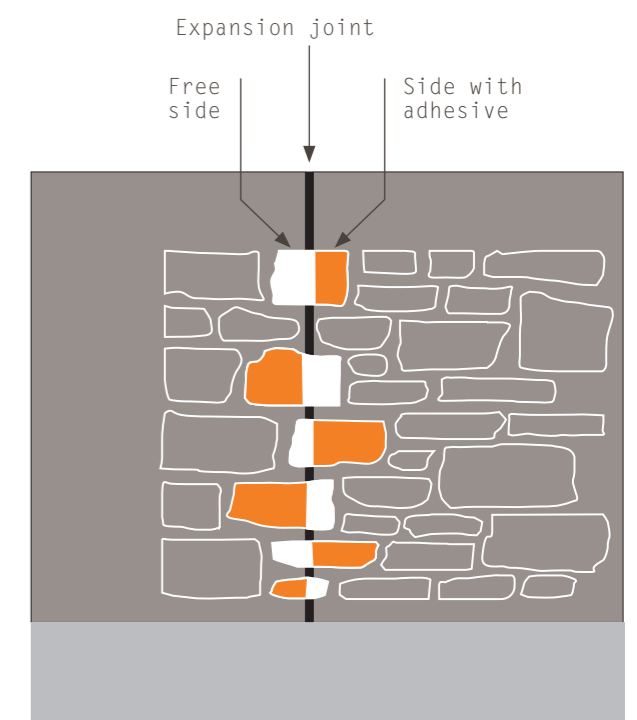

plus
murogeopietra



**9.5 MUROGEOPIETRA PLUS
DRY-STACKING INSTALLATION**

The characteristic of dry stone walls is the lack of mortar between stones, therefore walls owe their stability to the stones being combined and stacked correctly.

Although this isn't required with Geopietra manufactured stone veneer, thanks to the special GeoColl adhesive, for the purpose of authenticity it should always be installed as if a stone wall were being constructed, with the usual rules which that entails.

The COLOUR of the GeoColl adhesive in the BLACK and BROWN shades is an important feature in the DRY-STACKING TECHNIQUE for all shades of stone, with the exception of BT bianco terra and BM bianco marmo.

Coloured GeoColl that matches the stone avoids lengthy finishing operations with mortar, and creates a natural result.

Using the new, special GeoFit parts makes installation quicker and easier, and customises the final solution.

It is essential for the stone to be installed using a wet-on-wet technique.

Once the base has been prepared, mark horizontal lines approximately 30 cm apart, which are perfectly level, so the installation progresses as required. (Fig.1)

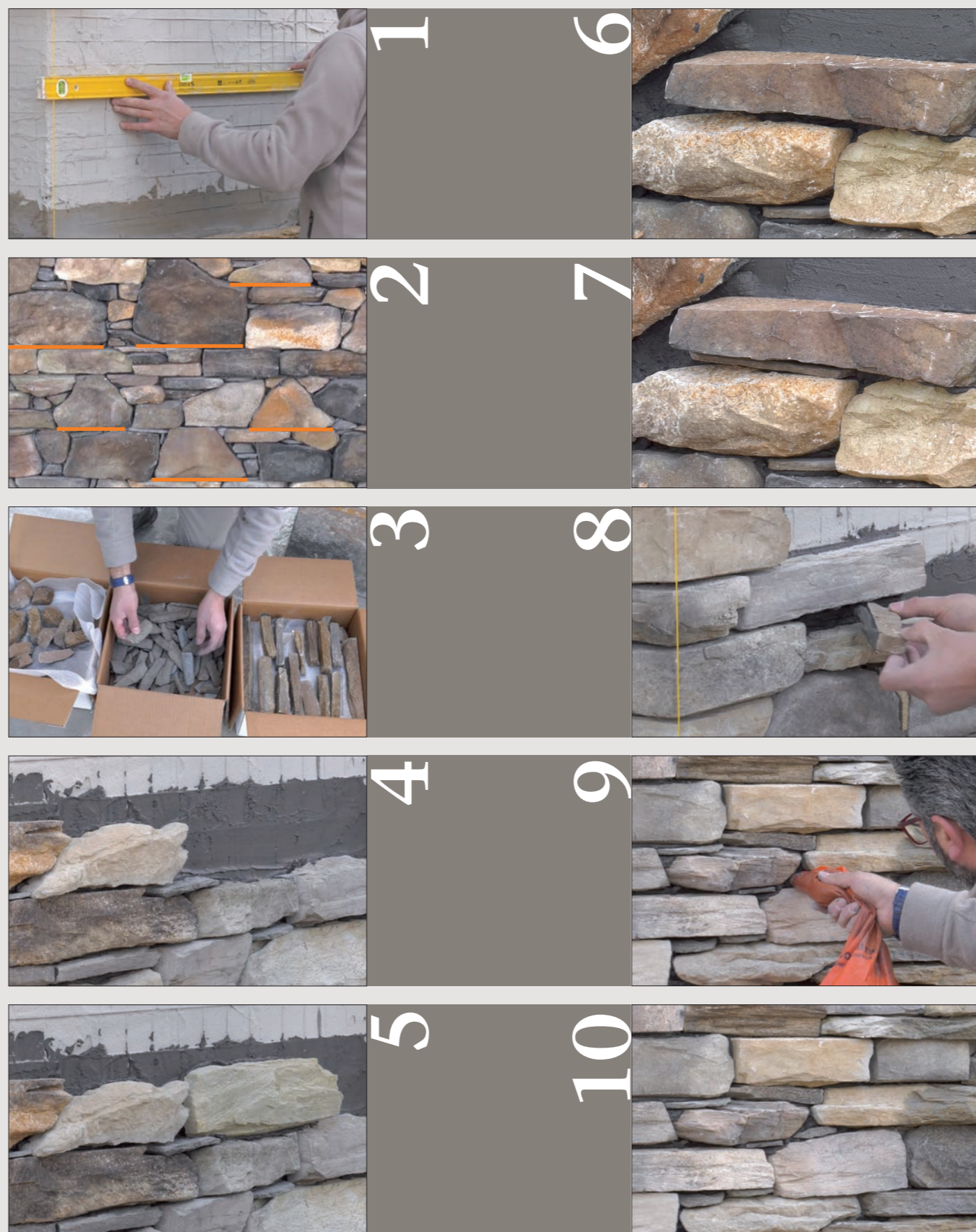

The stone must always be laid horizontally with the longest side down to achieve the most stable arrangement. (Fig.2) Sometimes edges may require some work, but endeavour to maintain the integrity of the shape of the stone as much as possible. If the visual balance of the next stone requires improvement, insert a GeoFit element in the correct shape (Figs. 4 to 8). Otherwise proceed with the remaining stones without worrying about empty spaces.

Continue to proceed horizontally, inserting taller stones every few metres to create joints. Never create vertical joints larger than the thickness of the stone itself, as this would be a weak point in a loadbearing wall.

After laying the stone, use the piping bag to inject adhesive into the empty spaces. Apply to the base of the GeoFit BIG or SASSO parts and insert them in the gaps.

This is not recommended with the SMALL chips given their size, as inserting the adhesive with the piping bag could foul stones nearby.

Remove any excess glue the day after using a stick or small metal implement.

GeoFit
e v o l u t i o n

*In case of **DRY-STACK INSTALLATION** of models which are not available in the **murogeopietra plus** version, consider 10-20% extra material when placing the order, in order to compensate the lack of the joints.*

murogeopietra plus DRY-STACK INSTALLATION consider 10-20% extra material when placing the order. Complete with Geofit according to the chart at pages 16/17.

10 | BREAKAGE AND DETACHMENT

It can be noted in the following pages how most problems have transpired when installing panel models, as they are often considered similar to tiles and therefore easy to install. The installation of Geopietra® wall coverings is completely different however, as a double application is required in addition to a careful assessment of the installation base. Geocoll® adhesive has special characteristics for dealing with the various stresses created between bases and wall coverings (see section 4).

1. CENTRAL BREAKAGE IN PANEL MODELS.

The crack shown in the photograph, found on the longer sections of panel models, can be caused by two installation errors:

- 1) applying adhesive between two spacers at the ends of the piece, where the stresses due to different thermal expansions cause breakage.
- 2) installing using a rubber mallet to make the section adhere to the base, resulting in the section cracking.



2. INCORRECT INSTALLATION ON A SKIM COAT.

A skim coat was applied to a plastered surface then the stone was glued without using a double application of adhesive. This resulted in the covering coming off completely (note the marks left by the adhesive in the lower part of the photo). The pull-off test carried out afterwards also shows the unstable condition of this base and the effectiveness of adhesion provided by the Geocoll® adhesive.

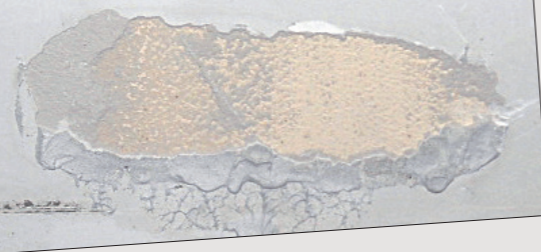

3. INCORRECT INSTALLATION ON EXTERNAL BRICK.

Structures subjected to bad weather are not usually implemented with absorbent materials. The case illustrated shows the results of a wall covering placed on an external brick base.

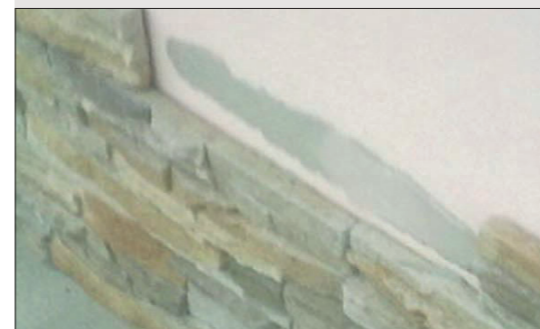

4. INCORRECT INSTALLATION ON A WET SKIM COAT.

Installation on plasterboard with a continuous glue skim coat newly applied caused the stone and adhesive to come off completely. When a fixing coat is applied to the base it is not possible to apply adhesive until it is set completely.

5. DETACHMENT WITH SURFACE PRIMERS.

The back sections of the P16 Scaglia model shown in the photograph had bonded perfectly, with adhesive spread well with a double application. The only issue is the blue mark which is due to the surface primer. It is crucial to distinguish between surface primers and deep primers. The former offer no support and the latter function with an absorbent base. If in doubt avoid using them and adopt another solution.

(See section 6 - Preparation of the Base).

6. DETACHMENT WITH PAINT.

Installation on any kind of paint causes the wall covering to come off through time.

7. INCORRECT INSTALLATION WITH 'DOTTED' ADHESIVE

resulting in the possibility of longer sections breaking near gaps. A double application has not been put on the piece and the base, in accordance with the wet-on-wet installation technique. It can also be clearly noted that the adhesive has overheated due to installation during the summer on a base which was too hot and absorbent.



8. INCORRECT INSTALLATION WITH 'DOTTED' ADHESIVE ON REINFORCED CONCRETE

in winter with the wall temperature close to or lower than 0°C and the presence of a film of water due to washing the base with a pressure washer and applying adhesive without waiting for it to be completely dry. The same issue can transpire in the presence of release agents, waterproofing treatments or bonding additives that form a film. A double application has not been put on the piece and base, in accordance with a wet-on-wet installation technique.



9. INCORRECT INSTALLATION WITH TOO LOW TEMPERATURES

and resulting frost shattering of the adhesive. It can also be noted that a double application was not carried out, even though in this case it would only have prolonged adhesion by a few years and would not have prevented detachment in any case.



10. INCORRECT INSTALLATION USING SPATULA WITH TEETH

and application of Geocoll® on the base only, with the piece simply being fitted with a ceramic tile technique. Grip is insufficient for withstanding the forces resulting from the various thermal expansions between the wall covering and the loadbearing base. A double application has not been put on the piece and base, in accordance with a wet-on-wet installation technique.



11. DETACHMENT DUE TO WATER INFILTRATION.

The photographs show a typical example of detachment due to water infiltration. Note the dark mark near the coping joint and the formation of a small area of limescale lower down, both due to the water running through the joint over time. It can also be clearly noted that a double application was not carried out, even though in this case it would only have prolonged adhesion by a few years and would not have prevented detachment in any case.

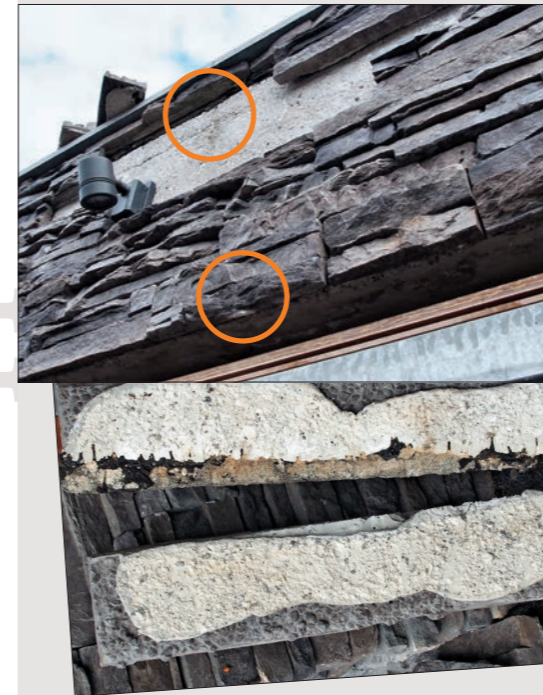

12. DETACHMENT WITH FILM FINISH.

The use of a surface waterproofing treatment instead of a deep primer has caused the covering to come off, in addition to the failure to apply a double coat of Geocoll®. (See section 6 - Preparation of the Base).



11 | INSTALLATION RULES



HORIZONTAL INSTALLATION

On loadbearing walls stones must always be positioned horizontally following the grain. They must connect together with perfect joints and never with vertical joints. Installing horizontal courses is natural and essential, as with the natural development of walls while being constructed.

(The photos compare the installation of the same Geopietra® manufactured stone veneer).

NO : rules have not been followed in terms of aesthetics to produce an authentic look, horizontal courses and correct joints between pieces, or grouting. The three-dimensional nature of the wall covering has been ruined and only the decorative character of the flat pieces used in a mosaic pattern is obvious.

YES : following and focusing on the installation rules makes it impossible not to appreciate the supporting role of the **murogeopietra** and not just the aesthetics.



ARCHES AND PILLARS

The load of forces with a loadbearing wall near an opening are distributed transversally as a result of an arch (or in the small openings via the vertical installation of some stones).

(The material in the first photograph isn't Geopietra®)

NO : Even though the progression of the arch in the wall underneath has been followed, the stones are positioned alongside each other without any supporting joint effect (note the formation of the + mark and the joint). Furthermore, the chosen model of stone and the pillar sections are not in proportion and the blend of colours is unnatural. This installation does not look authentic.

YES : Thanks to the vertical positioning which gives the loadbearing arch shape our covering looks totally authentic.



BEAMS WITH WIDE HORIZONTAL OPENINGS

The load of forces with a loadbearing wall in the case of wide horizontal openings and in place of an arch must be distributed over a beam or support along the entire opening.

NO : Covering wide openings by just fitting something over what is already there (an issue which is increasingly prevalent in modern building) does not give a convincing result. Irregular, chaotic installation hints at a vague idea of a loadbearing wall. There are no suitable ground supports and architraves in proportion, even hypothetically, to the weight of the stone construction.

YES : The simple insertion of a decorative beam satisfies, even if only visually, the need for a wall support above the opening and makes the work look authentic.



BALCONIES

Balconies covered with stone do not give an authentic-looking result without a loadbearing structure from the ground which would be required to support the weight in theory. Therefore in accordance with the rules of architecture only solutions where the use of the stone is plausible should be considered.

NO : If the intention is to achieve authenticity with manufactured stone veneer, covering an overhanging balcony without a ground support will not give the desired result. Likewise, the use of corner pieces on the lower part is incorrect and counterproductive with regard to looking plausible.

YES : Covering a balcony in manufactured stone veneer requires ground supports and architraves which would be proportional to a hypothetical construction in natural stone.

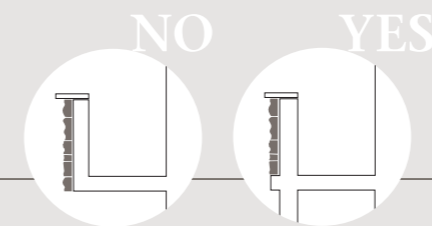

CORNERS and THICKNESS

Current trends in architecture favour natural stone alongside other construction materials, producing solutions that enhance aesthetic value especially.

NO : The photo shows an error in the corner finish on the house. Disregarding finishing details such as this can make even a good installation seem unrealistic. Work on corners should never come to an abrupt end. To give the covering a three-dimensional nature corner pieces should be used to continue along the corner of the wall for at least 25-40 cm.

YES : The use of corner pieces in structural details gives the **Geopietra**® wall covering a convincing three-dimensional nature and makes it perfectly realistic.



PARTIAL WALL COVERINGS

When renovating old stone houses any interesting wall sections to be restored should be left visible, and as a result embedded with respect to the new plaster.

NO : The partial covering on the wall was NOT finished off as required to make it look authentic. Only the decorative nature of the stone is highlighted. The need for the manufactured stone veneer to be thin must not be 'detected' with the installation, so that an authentic result and three-dimensional quality are obtained.

YES : For the partial installation of the **Geopietra**® covering the thickness of the uncovered wall was increased by applying insulation. It is also possible to create a recess in the wall where the covering can be installed. With both solutions the wall covering acquires a visual three-dimensional quality.

11.1 Tips for installing on thermal insulation / WINDOWS AND DOORS



1

For plaster finishes on window and door openings a frame must be fitted which is approximately 6-cm thick, in order to conceal the thickness of the stone. This frame can be made from off-cuts of insulation material glued to the insulation using a suitable adhesive, and a reinforcement mesh trimmed and embedded. Cover the frame with coloured finishing plaster.

- A. Insulation panel
- B. Fireproof safety panel
- C. Frame with reinforced insulation material applied
- D. Polyurethane foam
- E. Strip of seal
- F. Layer reinforced with mesh and finish to follow
- G. Corner profile
- H. Profile with drip feature

Window edge with frame finished and coloured

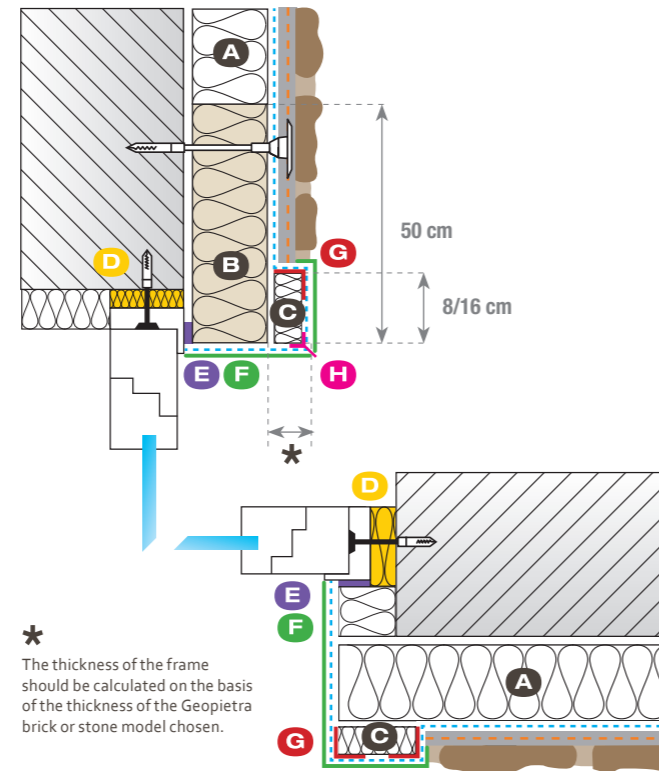

* The thickness of the frame should be calculated on the basis of the thickness of the Geopietra brick or stone model chosen.



2

To make the jambs flush with the stone cover the window border with insulation material. Then cut the frame with the cutter to insert the stone such that once grouted with the mortar it is embedded flush. Leaf hinges can be secured to the edge created, having already arranged special assembly mounts before installing the insulation.

- A. Insulation panel
- B. Fireproof safety panel
- C. Frame with reinforced insulation material applied
- D. Polyurethane foam
- E. Strip of seal
- F. Embed the stone using the cutter to cut a part of the insulation.
- G. Corner profile
- H. Skim coat with GeoBi mortar.

Window border with stones embedded flush

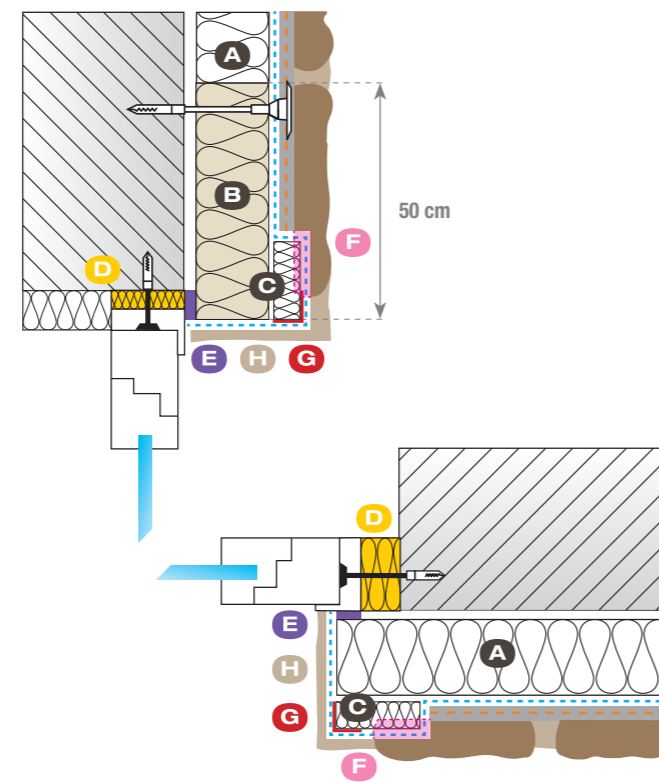

* The thickness of the beam should be calculated on the basis of the thickness of the Geopietra brick or stone model chosen.



3

A small wooden beam used to be inserted above windows in many stone constructions and had a twofold function - to provide initial support for the arching and decorate the window. To reproduce the same visual effect fit the stones on the side corners of the opening first, up to the required height, and insert the beam with a length equal to the opening, resting it on the corners, then proceed with the flat stones. In the case of large openings with long beams arrange fasteners in the central section.

- A. Insulation panel
- B. Fireproof safety panel
- C. Polyurethane foam
- D. Strip of seal
- E. Corner profile
- F. Elastic waterproofing reinforced with Georete mesh
- G. Closure strip

Window architrave with support strip

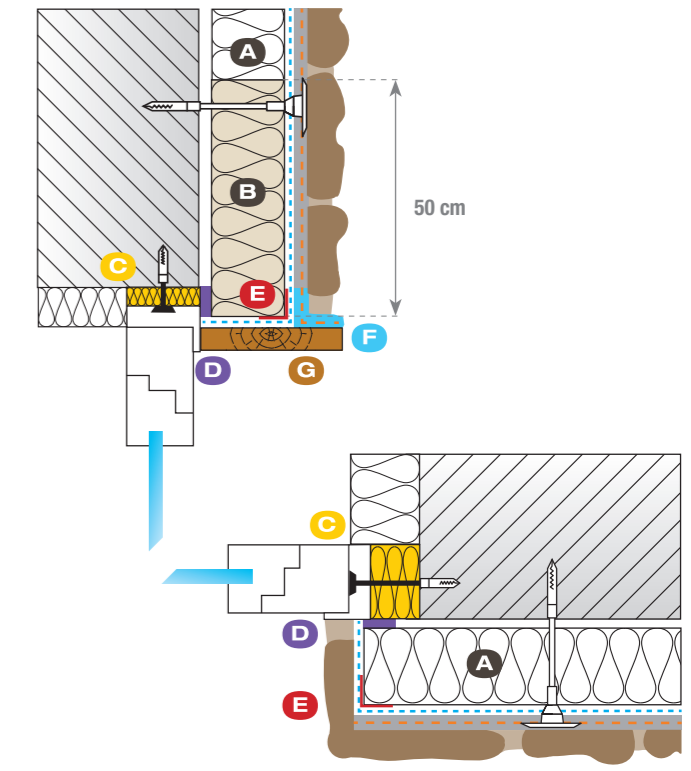

* The thickness of the beam should be calculated on the basis of the thickness of the Geopietra brick or stone model chosen.

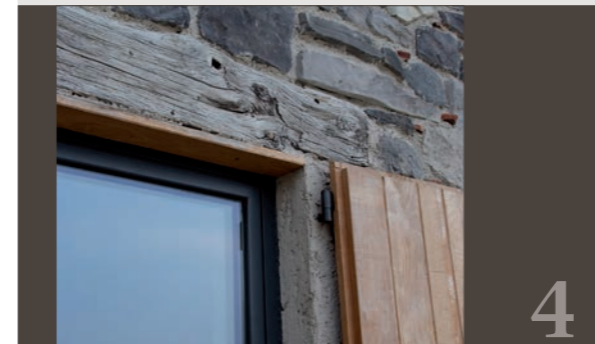

4

The simple insertion of a decorative beam satisfies, even if only visually, the need for a wall support above door and window openings and makes the work look authentic. Fit a wooden beam sawed to the thickness of 5-6 cm to the upper part of the opening and cover the rest of the border with installation material. To fit any leaf hinges use special assembly mounts fitted before installing the insulation.

- A. Insulation panel
- B. Fireproof safety panel
- C. Polyurethane foam
- D. Strip of seal
- E. Corner profile
- F. Galvanised metal mesh with large mesh secured with staples
- G. Closure strip
- H. Wooden beam section.

Window architrave with wooden beam

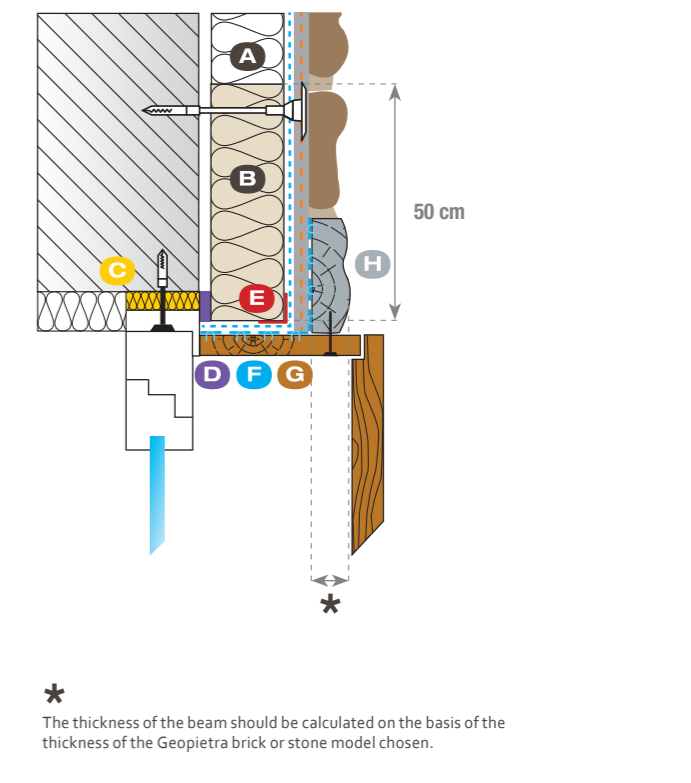

* The thickness of the beam should be calculated on the basis of the thickness of the Geopietra brick or stone model chosen.



5

To make the architrave more authentic extend the arch by a couple of stones past the window panel.
Window and door embrasures can be covered with corner pieces in manufactured stone veneer in the model chosen, remembering that the irregularity of the surface will not permit door leaves to be fitted. Monoblocks can be used for inserting leaves, where the closure is separate from the corner finish.

- A. Insulation panel
- B. Fireproof safety panel
- C. Strip of seal
- D. Polyurethane foam
- E. Corner profile

Window border with embrasure covered in stone

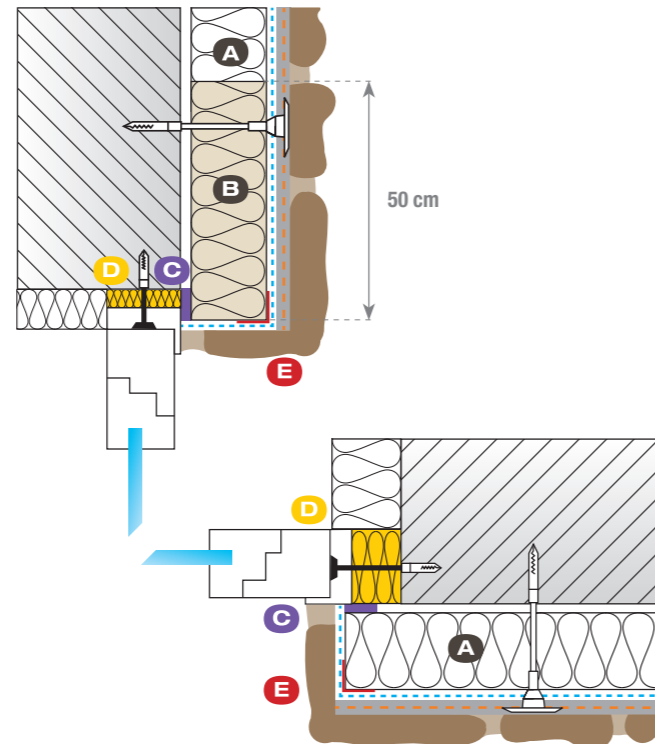

On the Geopietra channel watch the video: "Windows and Doors" on how to fit the stone on lintel finishes.



6

Windows and door frames can be finished off in various ways and some examples have been provided.
The cross-section at the side shows the ideal procedure for installing a frame with skewed jambs.

- A. Insulation panel
- B. Fireproof safety panel
- C. Frame with reinforced insulation material applied
- D. Polyurethane foam
- E. Strip of seal
- F. Layer reinforced with mesh and finish to follow
- G. Aluminium profile with drip feature
- H. Profile with drip feature

Window border with architrave and skewed jambs

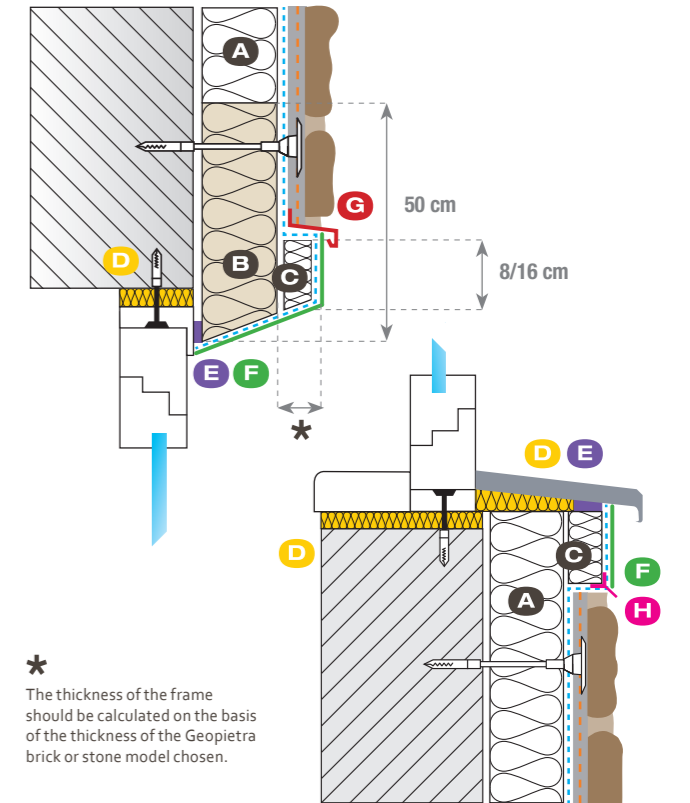

* The thickness of the frame should be calculated on the basis of the thickness of the Geopietra brick or stone model chosen.





When finishing off doors and windows maximum care must be taken with joints between coverings and the material bordering the opening, where thermal bridges can transpire and thermal expansion can cause cracks.

- A. Insulation panel
- B. Fireproof safety panel
- C. Strip of seal

Window ledge with drip feature

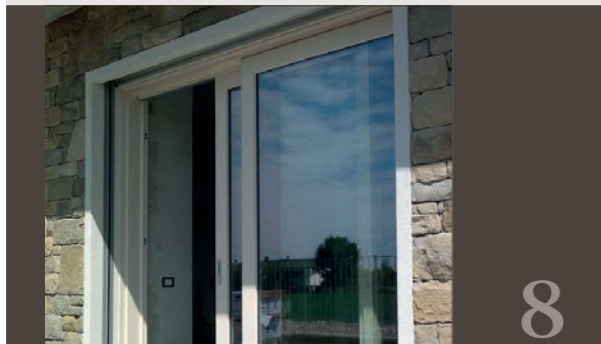
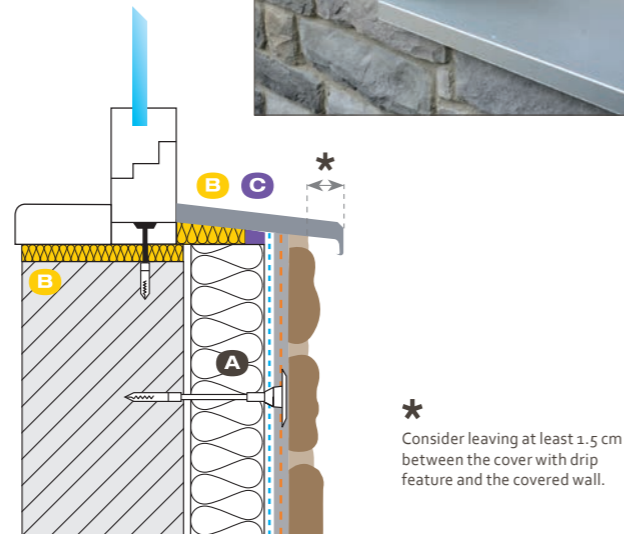

For finishes on window and door openings with built-in sunshade a frame must be fitted which is approximately 6-cm thick, in order to conceal the thickness of the stone. This frame can be made from off-cuts of insulation material glued to the insulation using a suitable adhesive, and a reinforcement mesh trimmed and embedded. Cover the frame with coloured finishing plaster.

- A. Insulation panel
- B. Fireproof safety panel with built-in sunshade
- C. Frame with reinforced insulation material applied
- D. Polyurethane foam
- E. Strip of seal
- F. Layer reinforced with mesh and finish to follow
- G. Corner profile
- H. Profile with drip feature
- I. Elastic waterproofing reinforced with Geopetra mesh

Window border with built-in sunshade

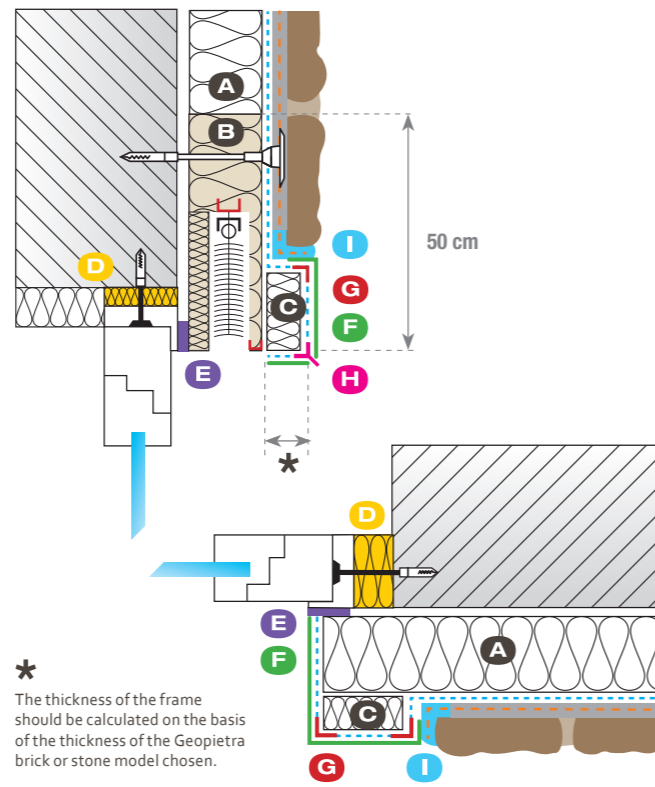

11.2 INSERTING WOODEN ARCHITRAVES

murogeopetra can be matched with numerous finishes depending on the kind of look required. One example is the continuation of classic loadbearing beams over doors in many homes typical of mountain dwellings, which are usually difficult to insert, especially with current construction systems i.e. with the presence of insulation where thermal bridges are essential.

The procedure outlined below has been tested by **Geopetra**® in many constructions, and makes it possible to obtain the appearance desired, e.g. with stone, while complying with all the requirements of the underlying base.

Take the selected wooden beam and cut the part to be visible to a thickness of approximately 5-6 cm. Staple a 5x5 cm galvanised metal mesh to the back with the edges overhanging by at least 7-8 cm. Using **Geocoll**® in two applications glue the beam to the base before installing the **murogeopetra**, covering the mesh totally.

11.3 CANTONALE

The corner has always played an important role in the supporting masonry, as it is a lifeblood for the stability of the whole structure.

CANTONALE P40 follows the soft rock used in some Mediterranean areas where the saw is cut and which surface is hammered. Cantonale is suitable for all types of stone and grouting. It is available in different colours so that it can be combined with the shades of stones.



- B BIANCO
- M MARRONE
- G GRIGIO



MODEL | **CANTONALE P40**
Available in 3 shades

CORNERS
mixed HEIGHT 30 / 35 cm
mixed LENGTH 40 / 50 / 60 cm
THICKNESS 4 / 5 cm

GEOBi



12 | GEOBI TWO-COMPONENT GROUTING MORTAR

Geopietra® has created the innovative **GeoBi** two-component mortar (dry/wet) which is ideal for finishing off **Geopietra®** manufactured stone veneer and brick wall coverings, and is suitable for indoors and outdoors. All **GeoBi** colours selected from typical soils and mortars in Europe have been standardised for use with various **Geopietra** models and shades.

GeoBi two-component mortar is available in 6 colours: SABBIA, MARCHE, TOSCANA, GRIGIO CHIARO, GRIGIO and ARENA and 2 grain sizes: fine grain 0-3 mm and coarse grain 3-8 mm. Thanks to its versatility it meets the most varied aesthetic requirements, ranging from rustic charm to smooth textures. **GeoBi** mortar has ideal flow characteristics for injecting joints using a piping bag. At the right consistency it doesn't drip and dirty the stone, doesn't shrink and crack when drying, and adheres perfectly to stone walls and bases. Traditional mortars or other ready-mixed products are not suitable.

PREPARATION

Mix **GeoBi/A coloured mortar** with 4.3-4.8 Lt of clean cold water for each 25-kg bag and create a smooth paste. Then add **GeoBi /B volcanic aggregate** in a ratio of 1:1 (7.5-lt bag) and mix until a smooth paste is obtained. Wait for approximately 10 minutes then mix again; processing time depends on temperature. With summer temperatures and very absorbent bases keep it at a fairly liquid consistency, and at a thicker consistency in winter temperatures (no lower than 5°C).

CAUTION: using material which is dry or comes from bags left open is problematic when handling the grout due to the prolonged absorbency of the aggregate.

APPLICATION

Cut the nozzle off the piping bag to obtain a suitable hole measuring 1.5-2 cm. Inject the material by keeping the end of the nozzle in the joint, tilting it sideways 45° with respect to the filling direction, and running it along the joint while gradually filling it. The material should always flow easily out of the piping bag without dripping on the stone while injecting. As this is a natural product the colour of the mortar may vary depending on factors such as wind, humidity, temperature and drying times. As a result avoid leaving a wall half grouted (from edge to edge), completing the work in one session. **GeoBi** can also be used to fill small gaps that occur during installation with half-filled joints.

FINISHING

Wait for the initial application to harden before proceeding with any other intervention. It is safe to proceed when water is no longer released when touching the mortar with a finger, and the material can now be worked using a wooden stick, spatula, glove or trowel, depending on the result required.

N.B. The mortar will mark the stone permanently, therefore keep the surface of the stone clean unless a plaster finish is required.

COLOUR

Pre-mixed coloured powder mortar | 6 colours



new



GRAIN SIZE

Wet volcanic aggregate | 2 particle sizes



FINE grain
0/3 mm



COARSE grain
3/8 mm



GeoBi F/fine grain (0-3 mm) is recommended for retouching dry-stack installations and finishing the **TERRAKOTTA brick slips**.

GeoBi G/coarse grain (3-8 mm) is recommended for finishing all **manufactured stone veneer profiles**.

With the advent of new construction requirements, grouting implemented with sand/cement-based mixes are inadequate. The different weight, breathability and thermal expansion characteristics between mortar and manufactured stone veneer create technical problems, such as the appearance of thermal bridges, excess weight, cracks etc. Thanks to **GeoBi**, the characteristics of the mortar are similar to those of **Geopietra®** manufactured stone veneer, standardising the technical characteristics of the finished wall. The wall is lighter, can breathe, and has a uniform composition.

GeoBi is therefore essential for installations on wood, insulation, asbestos cement slabs, and all other applications of Geopietra® manufactured stone veneer.

Grouting operations are simplified-joints are easily filled with a piping bag and processing times are reduced. **GeoBi widens the possibilities of grout finishes depending on how it is used.** Any type of finish can be achieved, ranging from the smoothest through to the roughest, typical of natural mortars. Processing times are crucial when choosing surface roughness requirements.

TECHNICAL ADVANTAGES

- Reduced grout weight.
- Even harmonised wall as it equalizes any thermal expansion of the joint and manufactured stone.
- Reduced thermal conductivity and hence no formation of thermal bridges.
- No risk of cracking as a consequence of shrinkage, which is typical of wide grouting joints.
- Increased breathability of grouting joints.
- Reduced formation of saltpetre from the joints.

AESTHETIC ADVANTAGES

- Due to its versatility, it can be used for any type of finish-from standard to relief-including plastering where grouting plays a major role.
- It gives the joint the rustic charm of old natural mortars with coarse or fine grain finishes.

APPLICATION ADVANTAGES

- Reduced processing time.
- Easy joint filling.

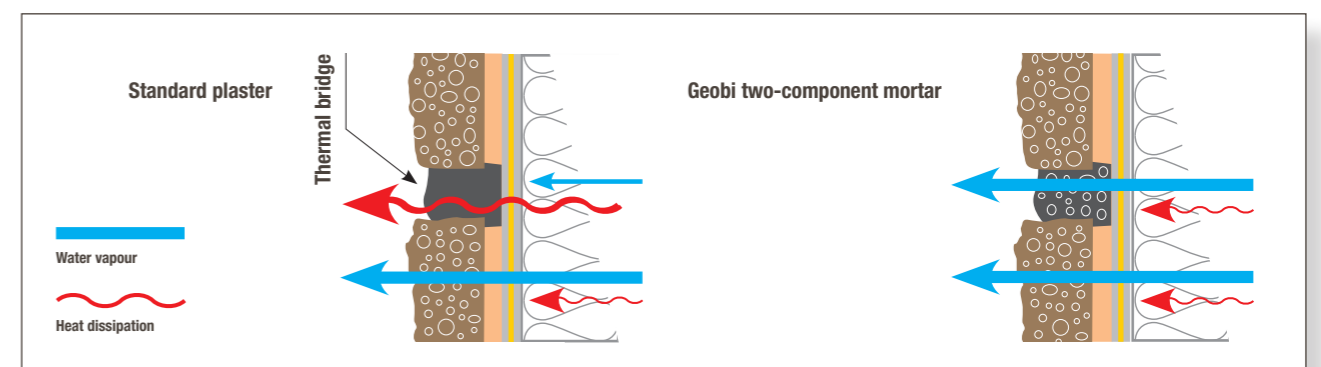

13 | GROUTING TECHNIQUE

1/2/3. Cut the end of the piping bag provided with the mortar to create a hole of approximately 1.5-2 cm.

4. DO NOT APPLY MORE MORTAR THAN IS REQUIRED ON A GRADUAL BASIS. The mortar should be ductile and friable, not too wet and not too dry.

5. THE PIPING BAG FILLED WITH THE MIX, should be supported in one hand while the other twists the upper section of the bag. This creates a pressure that pushes the material out of the nozzle.

6. THE NOZZLE MUST BE INSERTED DEEP INTO THE JOINT tilting sideways by 45° with respect to the grout direction. When injecting the material move at a speed that makes it possible to deposit the required quantity of mortar in the joint.

NEVER WORK WITH MORTAR WHICH IS STILL SOFT. Do not use WET spatulas, brushes or sponges.

Smoothing joints with brushes or wet sponges as typically occurs with stonemasons in some areas is to be avoided. In practice this operation deposits a thin film of lime on the stone in the form of a whitish film, which is invisible when wet but is not aesthetically appealing when dry.

7/8. CARRY OUT MANUAL CONSISTENCY TESTS to verify workability times. When surface water is no longer present (dry fingers) the mix can be worked and manipulated.

9. PRESS THE MIX INTO THE JOINT, removing any excess with a wooden stick and working it according to need and preference. Spatulas and trowels can be used for special mortar effects to recreate aged grouting or a scaling effect on walls (see section 14).

10. CLEAN THE AREA with a completely dry natural bristle or soft brush, observing grout setting times in relation to the finishing technique implemented (never clean immediately after working the mortar, always wait till dry).



Note! The colour of the mortar is sensitive to the following factors: type of manipulation, temperature, manipulation at different drying stages, rain or ice in the subsequent 48 hours. Changes in colour with the formation of marks or stains may transpire (see photo).



NO
YES



On the Geopietra channel you can watch the video: "Geobi and the Art of Applying Mortar Grout" with several examples of finishes

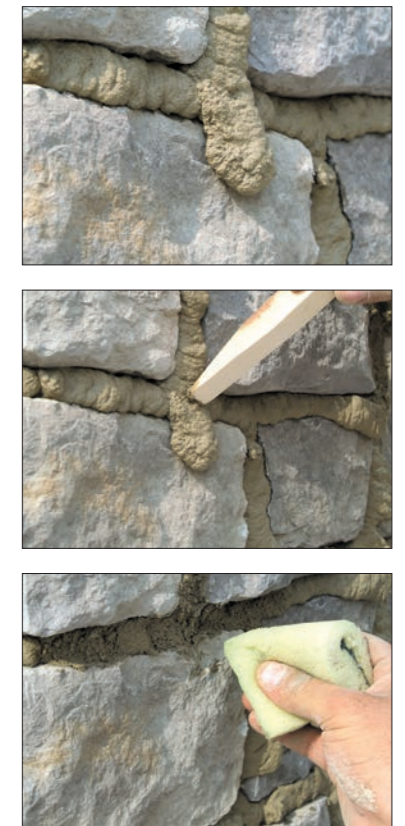

Avoid cleaning runs that are still wet on the stone, only remove them after initial shrinkage has occurred. Remove hardened lumps with a wooden stick then clean the remaining mark with a damp sponge, avoiding wiping where not required.

14 | SURFACE FINISH

On a stone-covered wall the joint grouting plays a fundamental role in aesthetic and practical terms.

The aesthetic and practical importance of grouting is often underestimated. Often anyone looking at a wall only focuses on the shape and colour of the stone and considers the finish as a simple addition, not realising that it is the composition in its entirety which appeals.

Grouting, or in some cases its absence, creates a surprising impact on the appearance of a manufactured stone veneer construction. It is generally good practice to look at antique or typical constructions in one's own area when **choosing the colour of the stone, mortar and type of finish**, so the construction is in keeping with local tradition. Otherwise it is

possible to draw inspiration for modern original solutions from the infinite combinations that **Geopietra® manufactured stone veneer** offers.

Choosing a mortar colour different to the stone creates a contrast which highlights the pattern and can be appealing on particular surfaces, whereas mortar with the same colour as the stone harmonises the wall assembly.

The finish is defined by various factors-joint dimensions and fill level, colour and mortar manipulation technique.

Geopietra® has designed **GeoBi** two-component lightweight mortar for manufactured stone veneer requirements, which is completely natural and available in 6 colours from typical mortar colours found throughout Europe. **GeoBi** is the ideal finish for **Geopietra®** manufactured stone veneer in technical terms and also in consideration of the range of aesthetic solutions provided. It makes it possible to obtain joints with a smooth, regular appearance or finishes with coarse grain, similar to old natural mortars. It is also useful for retouching dry-stack installations.



dry-stack joint



normal joint



full joint



over grout joint

This page shows the same model grouted in 2 different ways, illustrating the importance of a finish for the final result.

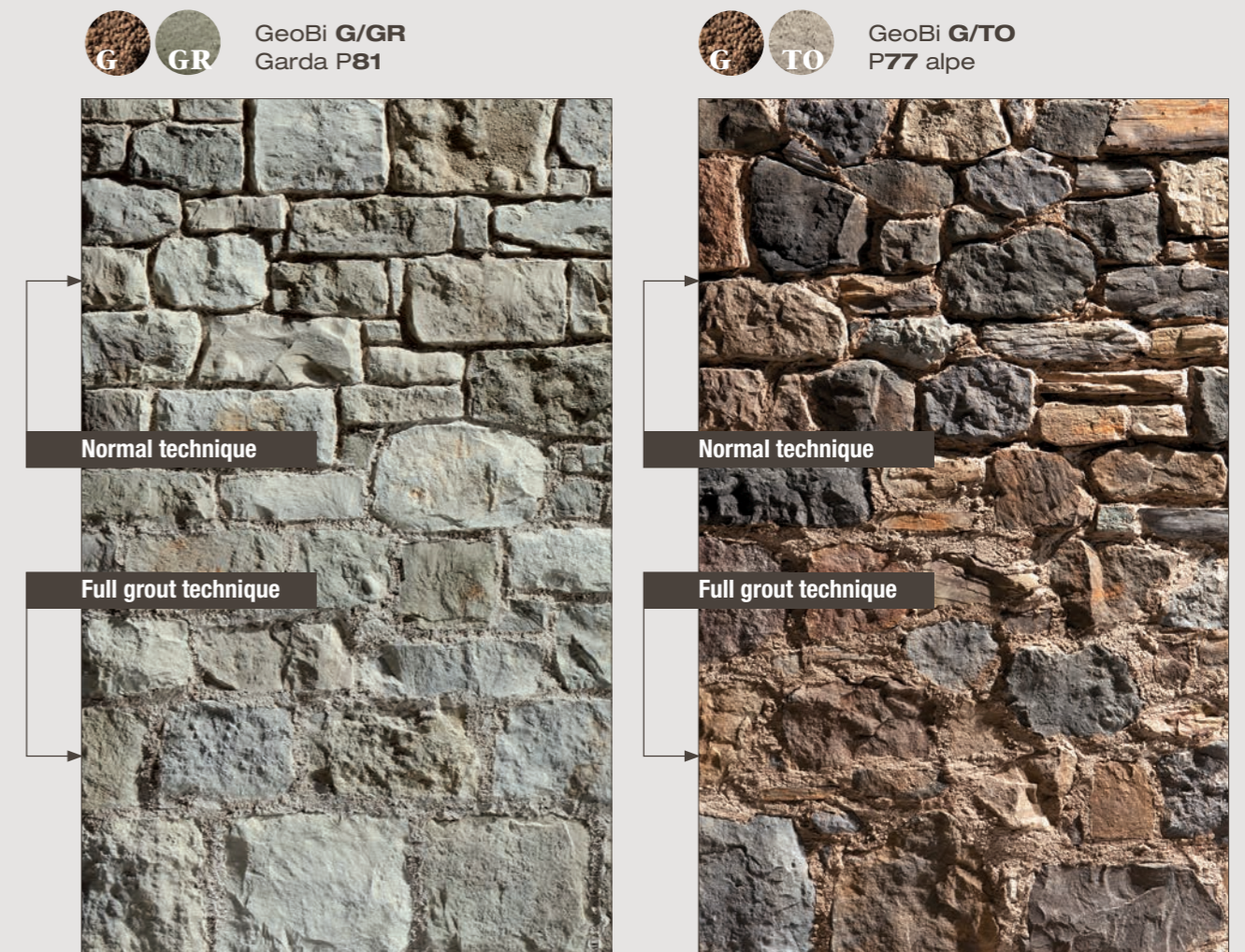



On the Geopietra channel you can watch the video: "Geobi and the Art of Applying Mortar Grout" with several examples of finishes

Very different and particular finishes can be created depending on the GeoBi manipulation technique and level of drying

GeoBI F/fine grain (0-3 mm) is recommended for retouching dry-stack installations and finishing the TERRAKOTTA brick slips. GeoBI G/coarse grain (3-8 mm) is recommended for finishing all manufactured stone veneer profiles.

In the past walls were cleaned and had old mortar removed and the new mortar inserted manually with a trowel. Filling the space till it was flush and partially covering the stone gave the wall continuity by maintaining typical projections and irregular features. With Geopietra® wall coverings and GeoBi mortars the procedure is simplified due to the reduced depth of joints, thanks to the product being convenient to use. GeoBi two-component mortar is inserted using a piping bag in the joints over the stone edge, and with the mortar still wet it is manipulated and distributed around the stones with a small trowel. Any unwanted runs on the stone can be cleaned with a sponge soaked with water.

In ledge stone constructions mortar was used to create support and close larger gaps between stones, therefore it was distributed at random depths and joints looked half-filled. To create a similar finish insert a small quantity (approximately 2 cm) of GeoBi mortar deep into the joints using the piping bag, wait 10-15 minutes and using the end of a square trowel work the mortar by slightly emptying the joints and cleaning the edge of the stones, such that the mortar only stays at depth, as if it had been inserted when constructing the wall.

Note: waiting times for the mortar to set are approximate as they depend on the temperature and weather conditions.



Some finish possibilities with GeoBi fine grain on brick slips.

15 | TERRAKOTTA: BRICK SLIPS

Using the same technology as manufactured stone veneer, Geopietra®, has produced a select range of brick slips. This solution is complete with models in **natural version** chosen in the best brick factories in Northern Europe. Individual models from popular areas are still produced with manual procedures, cut to a thickness of 25 mm from solid pieces.

The **Terrakotta** brick slips in the **natural** version has retained the charm and characteristics of traditional brick tried and tested throughout the centuries. Mixes passed down through generations and perfected in terms of cohesion and grip are baked in ovens at a temperature between 800°C-1200°C.

The **Terrakotta** brick slips in the **manufactured version** realistically produce the colours and textures of natural terracotta, adding rustic charm to recovered bricks. Also designed and optimised for use with all models of Geopietra® **manufactured stone**, **manufactured brick** has exceptional technical qualities and freeze resistance characteristics.

As a result of its characteristics, Geopietra® **manufactured brick** enhances the efficiency of thermal insulation and makes an external thermal insulation structure more robust and resistant by adding significant benefits.

15.1 INSTALLING BRICK SLIPS

Calculate joint thickness to obtain whole multiples to be distributed over the height of the wall.

Mark out horizontal lines equivalent to the sum of the brick height and the corresponding joint (or its multiples). Keep courses in line with a straight edge and level.

Model-specific information is outlined below to speed up the operation:

The brick covering can be installed from the bottom upwards or vice versa, as thanks to Geocoll® there are no issues with slippage. Corners should be installed first at the beginning of each course, alternating long and short sides.



H BRICK + H JOINT	x 2 =	H TRACKING	
4	0,8 / 1	4,8 / 5 x 2	9,6 / 10
5	1 / 1,5	6 / 6,5 x 2	12 / 13
5,5	1 / 1,5	6,5 / 7 x 2	13 / 14
6	1 / 1,5	7 / 7,5 x 2	14 / 15
6,5	1,5	8 x 2	16
7	1,5	8,5 x 2	17

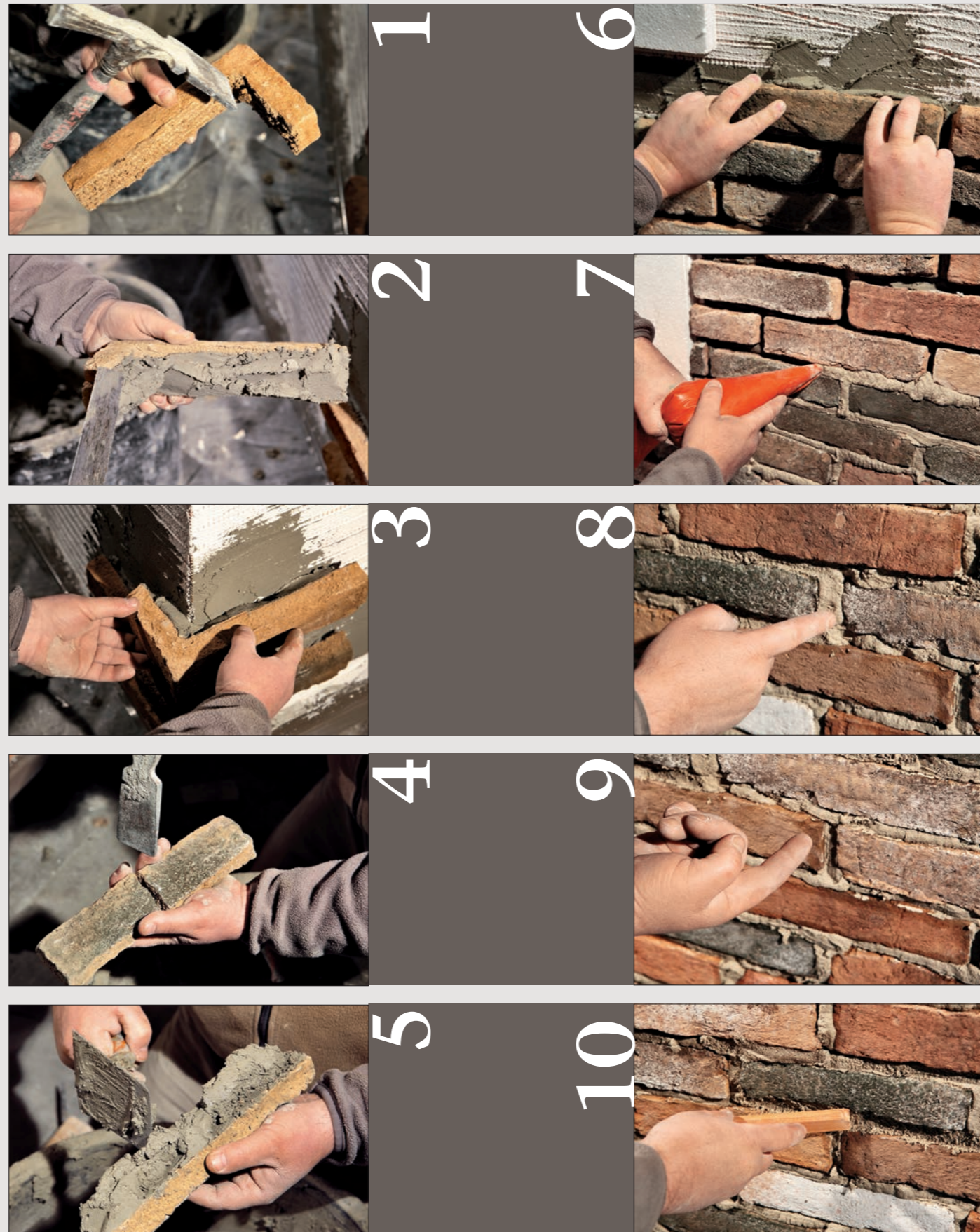
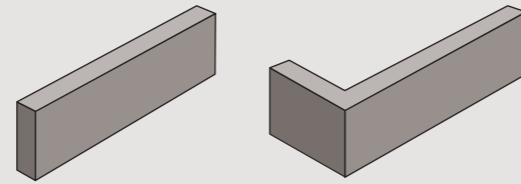

On the Geopietra channel you can watch the video: "Installing and Finishing Terrakotta Brick".

1. Clean any processing residue off the surface of corner strips before applying the adhesive.

2. The Geocoll® adhesive must always be placed on the back of the corner and stuck onto the brick and wall firmly with a trowel, working with a wet-on-wet technique.

3. Stick the corner down using slight pressure and small vertical movements (up/down) until a suction effect is obtained. Alternate long and short sides so the installation of subsequent courses is staggered.

4. If necessary cut the slips with a diamond blade or break it with a hammer.

5. The Geocoll® adhesive must always be placed on the back of the brick and the wall, working with a wet-on-wet technique.

6. Install the slips using slight pressure and small sideways movements (right/left) until excess adhesive is pressed out and the piece grips by itself. Remove excess Geocoll® before installing the next brick. Always stagger vertical joints.

7. Use GeoBi/F fine grain mortar with the piping bag provided to fill joints. DO NOT APPLY MORE MORTAR THAN IS REQUIRED ON A GRADUAL BASIS. Do not use WET spatulas, brushes or sponges.

8/9. CARRY OUT MANUAL CONSISTENCY TESTS to verify workability times. When surface water is no longer present (dry fingers) the material can be worked. It is only in finishes with a trowel or spatula that the mortar must be worked when still wet.

10. Remove excess material and press the remainder into the joints with a wooden stick, working it according to need and preference. The aesthetics of Geopietra® brick slips are emphasised by the finish, and as with the manufactured stone there are various different styles. (see section 14)

NATURAL BRICK SLIPS

After suitable drying, saltpetre formation is normal. For removal, simply apply a solution with water and hydrochloric acid (80% water + 20% hydrochloric acid) or an equivalent product that can be painted with a surface brush. Protect hands, face or other parts of the body with gloves from possible splashes. Do not use a water-repellent product or similar. Geopietra disclaims any responsibility for any damage resulting from the use of any product. A properly performed masonry does not require any treatment after cleaning.

16 | CLEANING AND MAINTENANCE

Geopietra® products are virtually maintenance free.

REMOVING ANY INSTALLATION RESIDUES

Take care not to soil the stone during installation. It is good practice to work with your hands clean at all time. Any glue stains must be removed at once with a clean sponge and water. During grouting, it is very important to comply with the statutory regulations set out in the Technical Manual: **incorrect application of the grouting, working with fresh mortar or unsuitable tools may stain the veneer irreparably.** If washing is required on completion of the installation and the drying process, proceed as follows:

1. Remove any hardened debris using a wooden stick.
2. Remove any halo and stains by washing the stone surface thoroughly with water, gently scrub with a sponge (or a dry soft bristle brush) soaked in a solution of water and white vinegar (maximum concentration 1 part white distilled vinegar to 5 parts water).
3. Rinse well with clean water.



ORDINARY CLEANING

Remove surface dust with a dry brush/broom.

Only use soft bristle brushes (sorghum) so as to avoid scratching the material. Then wash with clean water, as required, following the procedure below:

1. Prepare the stone by wetting it well with clean water only.
2. Gently scrub the stone surface with a soft bristle brush and, if necessary, soaked in a solution of mild detergent and water. Make sure the detergent does not contain any bleach or other harsh chemicals.
3. Rinse well with clean water.

EFFLORESCENCE

If dissolved salts deposit on the surface as the result of the drying process of the base, wait until moisture migration has completed and remove any deposits using a sorghum broom. Stains can be removed using a solution of 5 parts water to 1 part white distilled vinegar, rubbing gently with a soft bristle brush. Rinse well with clean water.

If the source of moisture persists, water will migrate slowly through the masonry base, due to improperly waterproofed walls. When water reaches the outer surface, it evaporates depositing dissolved salts in the form of strongly corrosive efflorescence. If efflorescence is extensive, it may be necessary to restore proper conditions and put in place specific remedies before installing the cladding. If efflorescence is localized, appears seasonally or is of a limited extent, it may be enough to treat with anti-salt spray, after cleaning.

PROTECTIVE TREATMENTS

Geopietra® manufactured stone veneer features duration and high resistance over time without requiring particular interventions.

Only in certain applications, in the presence of external agents, it may be necessary to apply a sealer. Like natural stone, Geopietra stone veneer is made up of natural ingredients, and is therefore exposed to the corrosive action of chemicals-such as salt, chlorine and acids - or may absorb liquids.

Exteriors: saline water, sea salt carried by the wind, chlorine dissolved in swimming pool water, salt and chemical products used for melting snow, are all dangerous products for the stone veneer.

Interiors: in public places and where the walls require special protection and cleaning, it is good practice to apply suitable protective treatments because the material may absorb fumes, oils or liquids. In such cases, there are various types of treatment with different degrees of protection and durability, some of which can alter both the outer appearance of the stone and its physical characteristics. When applying a protective treatment to Geopietra® manufactured stone veneer, we recommend choosing a siloxane-based formula, which leaves the "pore open", thus maintaining breathability.

Recent years' technical evolution has led to increasingly sophisticated protective treatments at the molecular level, which ensure longer life and better performance. Geopietra® is testing them to prove their actual effectiveness. For further details in this regard, please contact our design office.

WARNINGS

DO NOT use metal brushes on Geopietra® manufactured stone veneer.

DO NOT use acid detergent to clean Geopietra®.

DO NOT clean Geopietra® with high-pressure water jets.

DO NOT apply protective treatments to wet surfaces.

(wait at least 5-6 weeks after installation).

17 | GUARANTEES

Geopietra® manufactured stone veneer is guaranteed for 50 years from the date of purchase if used according to the manufacturer's instructions.

The Geopietra® warranty is limited to the original purchaser and cannot be transferred to a subsequent owner. The supplier will replace faulty items at no charge.

The Geopietra® does not cover damage caused by:

- Subsidence in constructions or other wall movements;
- Contact with chemical products or paints;
- Discolouration caused by air pollutants;
- Dirt or oxidisation.

The Geopietra® warranty covers product manufacturing defects. It does not cover labour costs for removing and replacing faulty products.

The warranty will be rendered invalid and retailers will not be liable for problems that arise in the case where the user does not follow the installation instructions and recommendations outlined in the Technical Manual provided with each supply (or available for download at www.geopietra.com), and does not use the Geocoll® and GeoBi products recommended by Geopietra® srl.

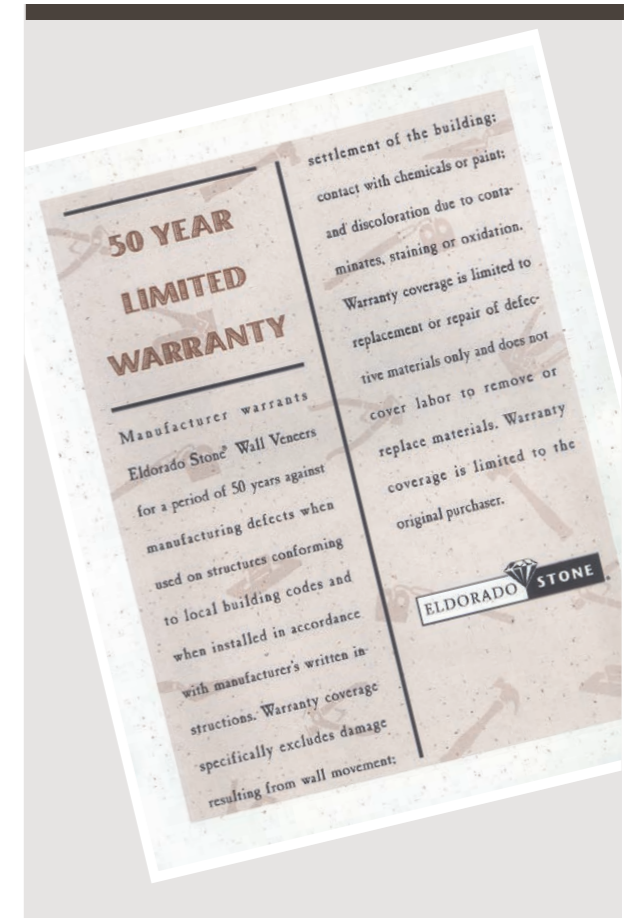

abitasistema



Geopietra ensures the Murogeopietra laying method on an ETAG 004-certified exterior wall thermal insulation system using EPS, rockwool and cork panels.

18 | LIGHTING PROJECT

new lighting project

OTTAGONO, STRIKER and CAPRI

A simple and innovative system for an installation without cracks, designed exclusively by Geopietra.



*The depth of the box in stainless steel can suit the various thicknesses of Geopietra stones but not that of Terrakotta bricks.

Thanks to the new system Geopietra, OTTAGONO, STRIKER and CAPRI can be integrated onto murogeopietra of traditional masonry or external thermal insulation without anchors and cracks, eliminating any problem of thermal bridge and giving maximum freedom of design.

18.1 Stainless Steel FRAME and CASE - INSTALLATION INSTRUCTIONS

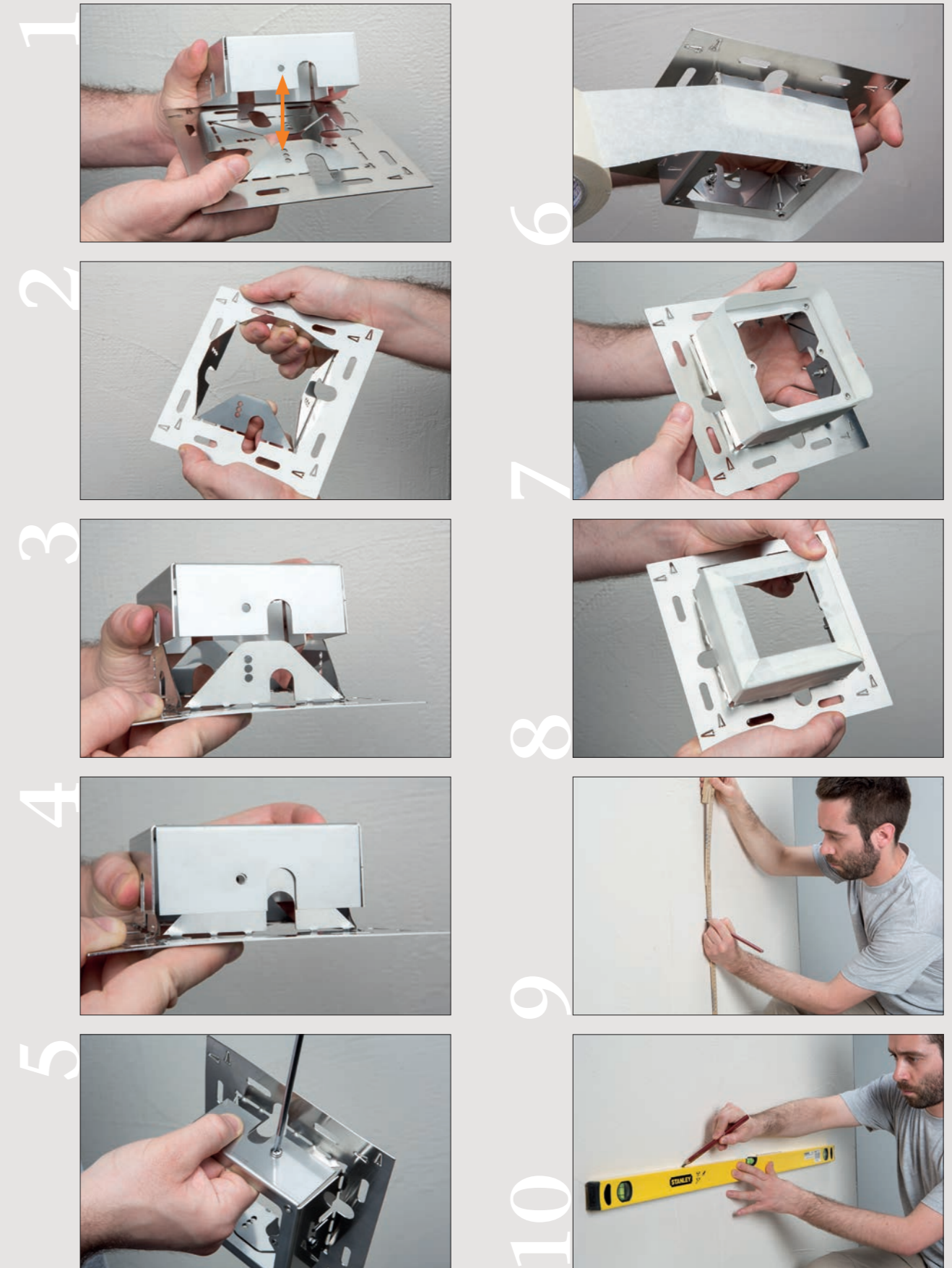

The FRAME and CASE are made of STAINLESS STEEL with depth adjustment for wall stone-flush installation of OTTAGONO, STRIKER and CAPRI lighting fixtures.

The FRAME consists of a pre-cut steel plate with four central wings that are bent at an angle of 90° to provide support for the CASE. In order to understand the exact bending side, move the FRAME closer to the CASE so as to align the holes receiving the screws for joining the two parts together.

When the correct side has been verified, bend the four wings to form a right angle with the base.

Of the 3 holes in the base, choose the one with the desired height according to the Geopietra stone veneer thickness. Insert the CASE on the inclined FRAME and lock it into position with the 4 screws supplied.

To prevent any residues of Geocoll adhesive and GeoBi grouting mortar from soiling the casing or clogging the threaded holes, protect the CASE with paper tape prior to installation.

Mark on the wall the exact position of the light source, taking into account horizontal and vertical alignment.

Mark the perimeter of the FRAME.

Use Geocoll adhesive of a suitable density (the same as that used to install Geopietra stone veneer) to ensure perfect adhesion to the wall at the FRAME supporting points. Leave at least two reference marks visible, which will serve as a track to maintain the horizontal alignment of the FRAME.

Place the FRAME with the secured CASE in such a way that the joining holes of the OTTAGONO or the supporting plate of the STRIKER (S-SUP) are positioned horizontally.

Push slightly to allow for any excess Geocoll adhesive to emerge from the existing holes, and spread it to cover the FRAME wings.

Check horizontal alignment with the still wet adhesive.

Use a 10mm diameter sheathing to connect the various containers, possibly with a power cable or a small pulling iron wire already inserted, and fix it to the base using Geocoll adhesive.

The light sources can be mounted in series and any transformers can be housed in a separate suitable slot.

Cover the FRAME wings with Geopietra stone veneer and lock it firmly into position.

Choose the lowest stone units to coat the sheath for a harmonious, smooth finish effect.

Apply GeoBi mortar for grouting and when the mortar has set, use a cutter to cut the paper tape flush to the grouting and uncover the edges of the CASE.

When the electrical connections have been completed, you can mount the OTTAGONO, STRIKER or CAPRI fixtures, as required.

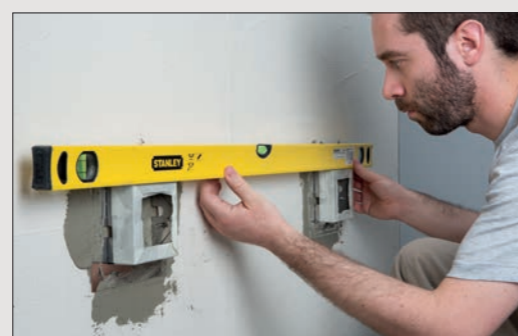
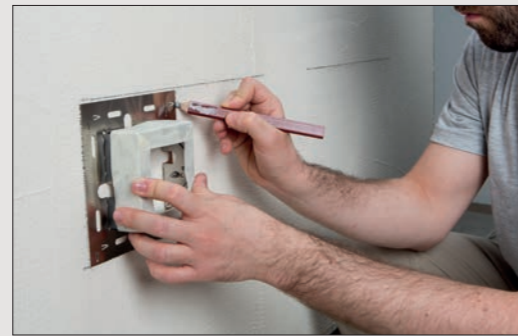

11

12

13

14

15

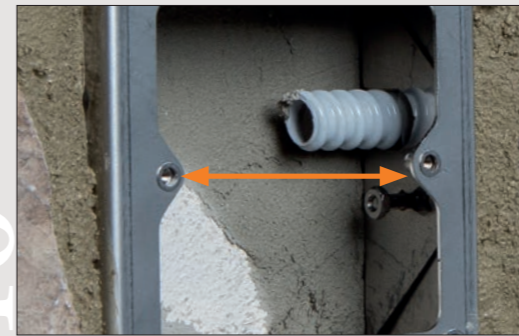

16

17

18

19

20

21

22

23

24

25

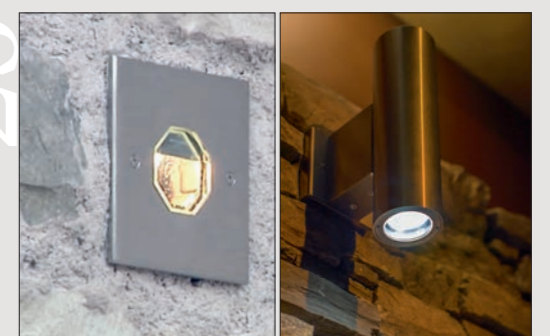

This technical manual replaces all previous information and versions. The data shown in the operating guidelines reflect the knowledge and in-field experience acquired during use. All data were processed in an accurate, responsible way, though we cannot guarantee its accuracy and completeness and hereby disclaim all liability for specific solutions decided by the end user. Data itself does not entail any sort of legal constraint or ancillary obligation, and does not hold the customer harmless from the responsibility of checking by itself the suitability of the product for the intended use. Our products, as well as all the raw materials they are made of, undergo continuous monitoring to guarantee consistent quality. Our design office provides advice on how to use and install our products and free demonstrations. An updated version of our product specification and safety data sheets can be obtained on request.

Any partial or total reproduction of the images and text contained herein, using mechanical media or otherwise, unless specifically authorised in writing by Geopietra Srl, constitutes an infringement of copyright liable to prosecution.



Geopietra S.r.l.

Registered office

Via della Ferrovia, 74/E
25085 Gavardo (Bs) ITALY
REA: N° BS 349756
Tax code and VAT
N° BS 01774300980
Cap. Soc. € 50.000,00 i.v.

Headquarters

Via Industriale, 71 - 25080
Castrezzano di Muscoline (Bs)
tel +39.0365.331411
fax +39.0365.34142
info@geopietra.it
www.geopietra.com

